



**MUMBAI METROPOLITAN REGION
DEVELOPMENT AUTHORITY**

**MASS RAPID TRANSIT SYSTEM
FOR
VERSOVA-ANDHERI-GHATKOPAR CORRIDOR IN MUMBAI**

VOLUME II B of IV

DRAWINGS

RELIANCE Energy
Anil Dhirubhai Ambani Group

 **VEOLIA**
TRANSPORT



MUMBAI METROPOLITAN REGION DEVELOPMENT AUTHORITY

MASS RAPID TRANSIT SYSTEM FOR VERSOVA-ANDHERI-GHATKOPAR CORRIDOR IN MUMBAI

VOLUME II B of IV

DRAWINGS



RELIANCE Energy
Anil Dhirubhai Ambani Group

VEOLIA
TRANSPORT

DOCUMENT TREE

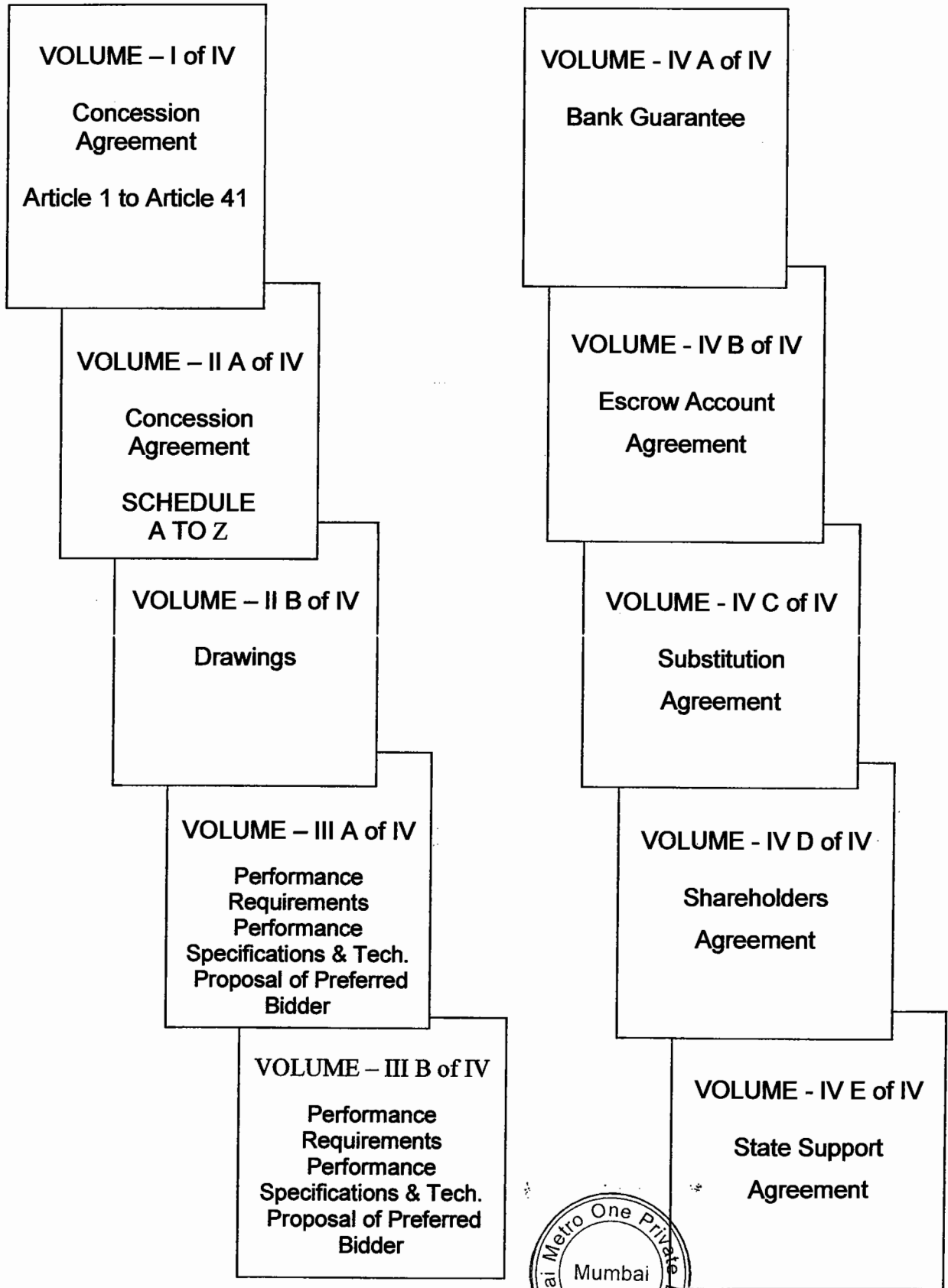

TYPICAL DRAWINGS

VERSOVA-ANDHERI GHATKOPAR MRTS CORRIDOR

- PART A: APPROXIMATE ALIGNMENT DRAWINGS (Sheet 1 to 62)
- PART B: TYPICAL (SCHEMATIC) STATION DRAWINGS
- PART C: LAND DELETED FROM RESERVATIONS & RESERVED FOR "MRTS CAR DEPOT/ WORKSHOP AND ALLIED ACTIVITIES AND COMMERCIAL USE"

fi

The enclosed Drawings are indicative and may undergo change based on final location survey.

[Signature]



PART A
ALIGNMENT DRAWINGS

Sheet 1 to Sheet 62

From Approximate Chainage 3700 to E7700





MUMBAI MRTS PROJECT
VERSOVA - ANDHERI - GHATKOPAR CORRIDOR
CHAINAGE :- W3500.00 - W3300.00

VERSOVA ←

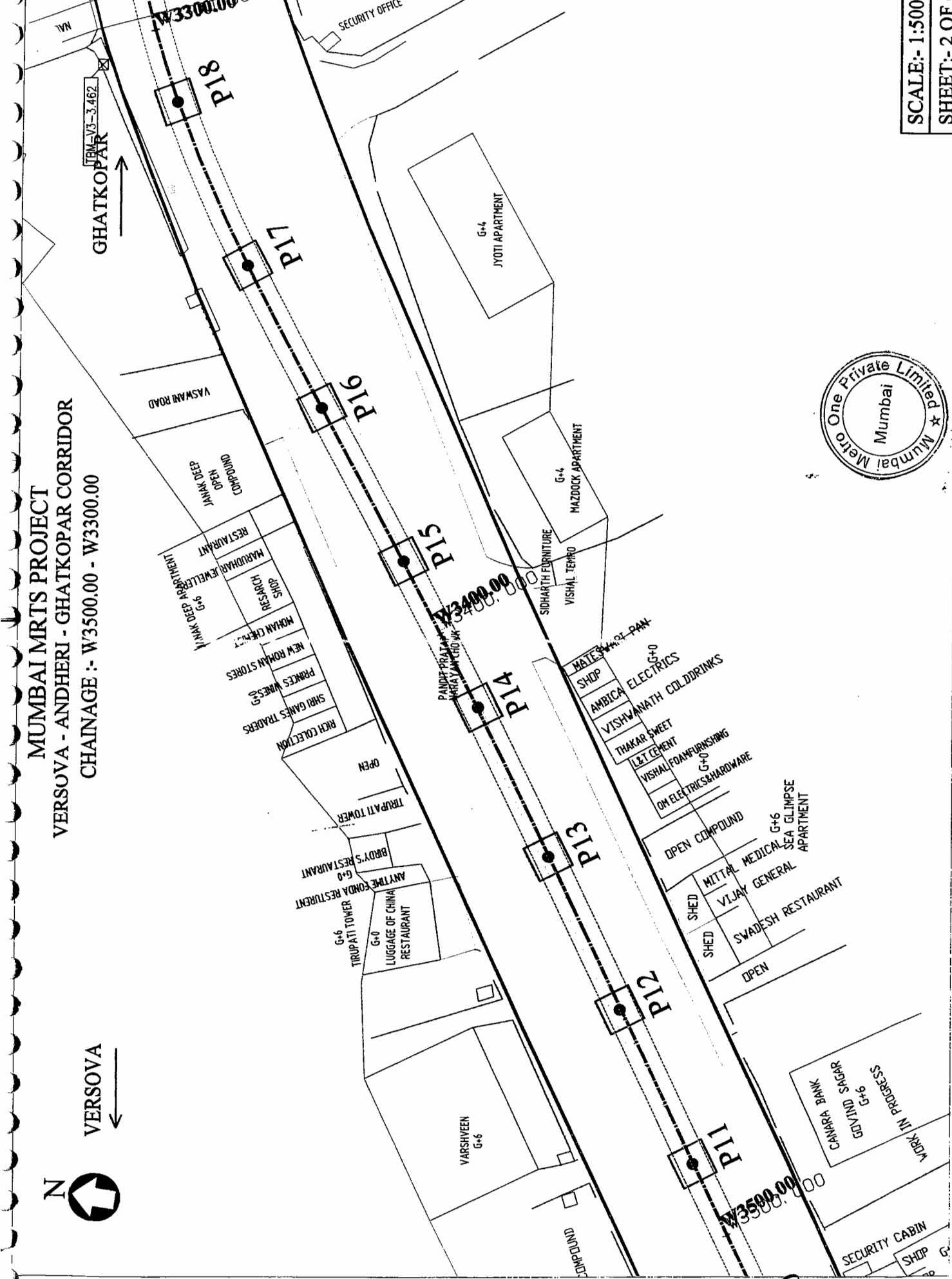

VERSOVA STATION

SCALE:- 1:500
SHEET:- 3 OF

GHATKOPAR
→

MUMBAI MRTS PROJECT
VERSOVA - ANDHERI - GHATKOPAR CORRIDOR
CHAINAGE :- W3300.00 - W3100.00

SEVEN BANGLOW BUS DEPOT
SAAT BANGLOW BEST BUS DEPOT
SAAT BANGLOW BEST BUS DEPOT



DEAD END CH W3207.10

W3200.00

W3100.00

P19

P20

P21

P22

P23

P24

G+6
GAUTAM MYAS

G+3

G+3

RAJAT REKHA

G+3

TRANS FORVER
G+0

BALKRISHNA CO. OP. HSG. SOCIETY

G+4

G+4

SECURITY

EVER SWEET APARTMENT
G+4

SAVEN BANGLOW BUS STOP
W3100.00

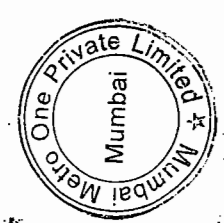

MUMBAI MRTS PROJECT
VERSOVA - ANDHERI - GHATKOPAR CORRIDOR
 CHAINAGE :- W3100.00 - W2900.00

GHATKOPAR →

← VERSOVA
 N
 FOREST

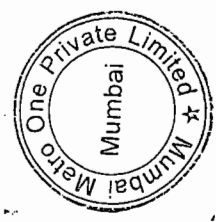
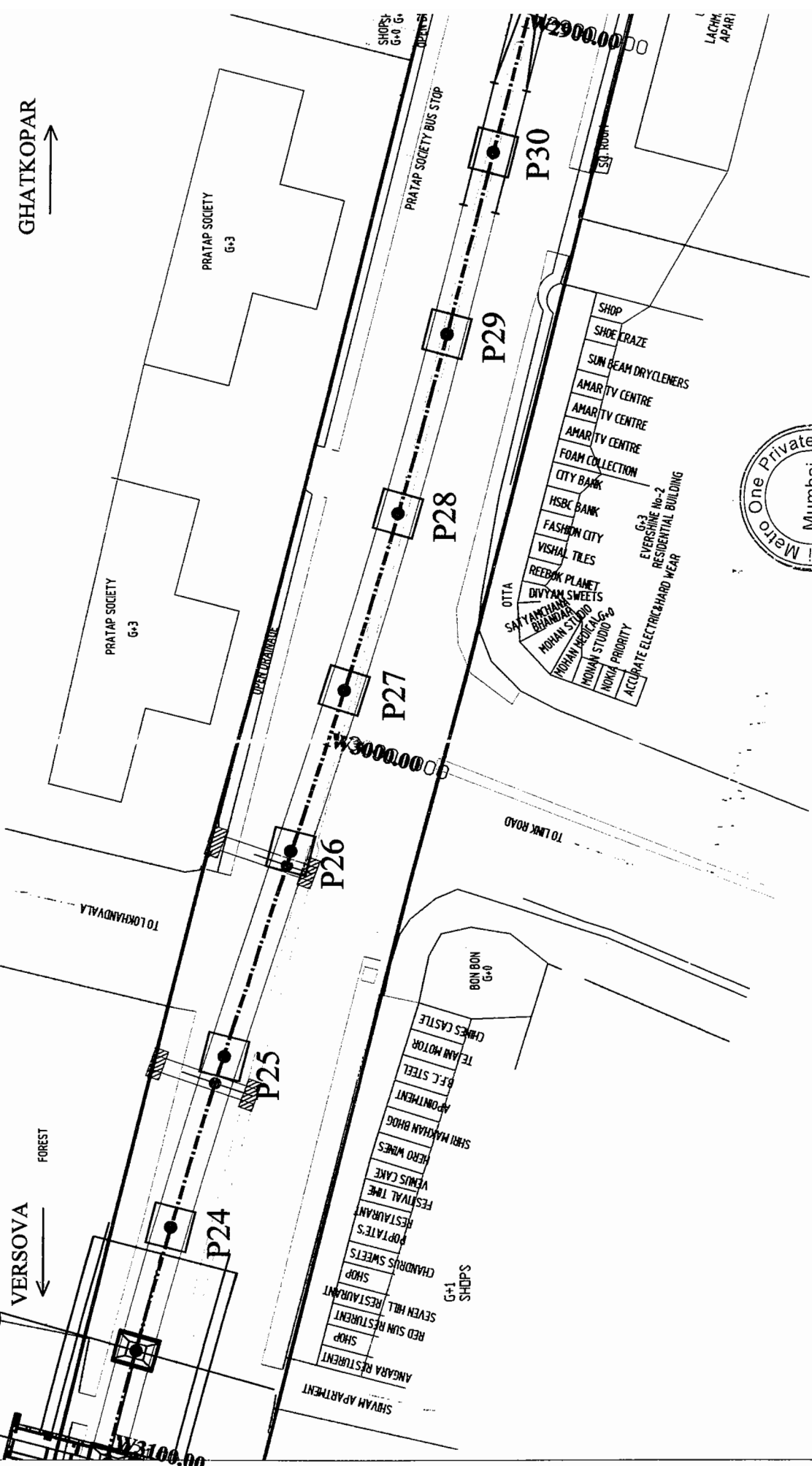

MUMBAI MRTS PROJECT
 VERSOVA - ANDHERI - GHATKOPAR CORRIDOR
 CHAINAGE :- W/2900.00 - W/2700.00

GHATKOPAR
 →

VERSOVA
 ←

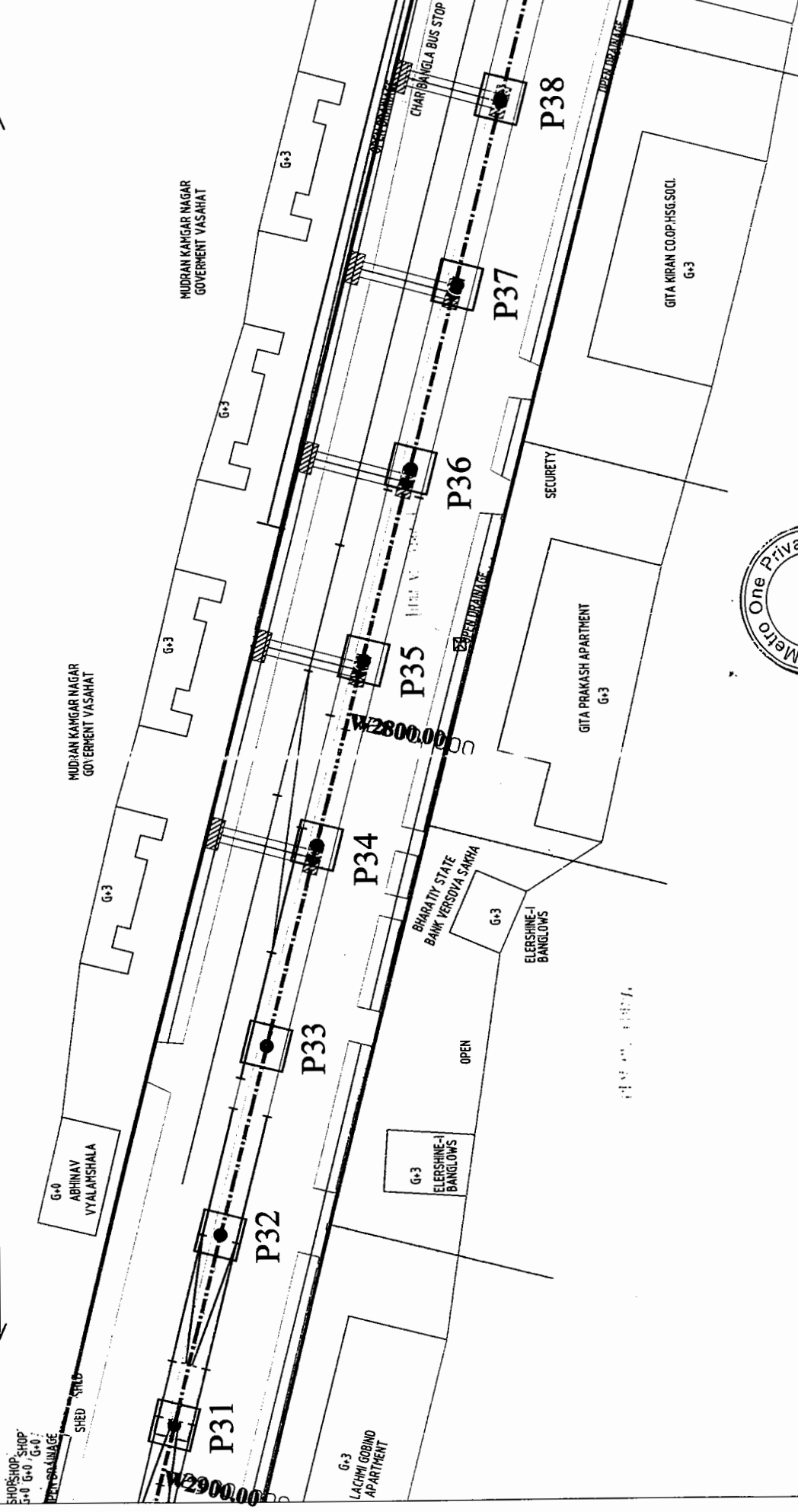

SCALE:- 1:50
 SHEET:- 5 OF

MUMBAI MRTS PROJECT
VERSOVA - ANDHERI - GHATKOPAR CORRIDOR
CHAINAGE :- W2700.00 - W2500.00

GHATKOPAR

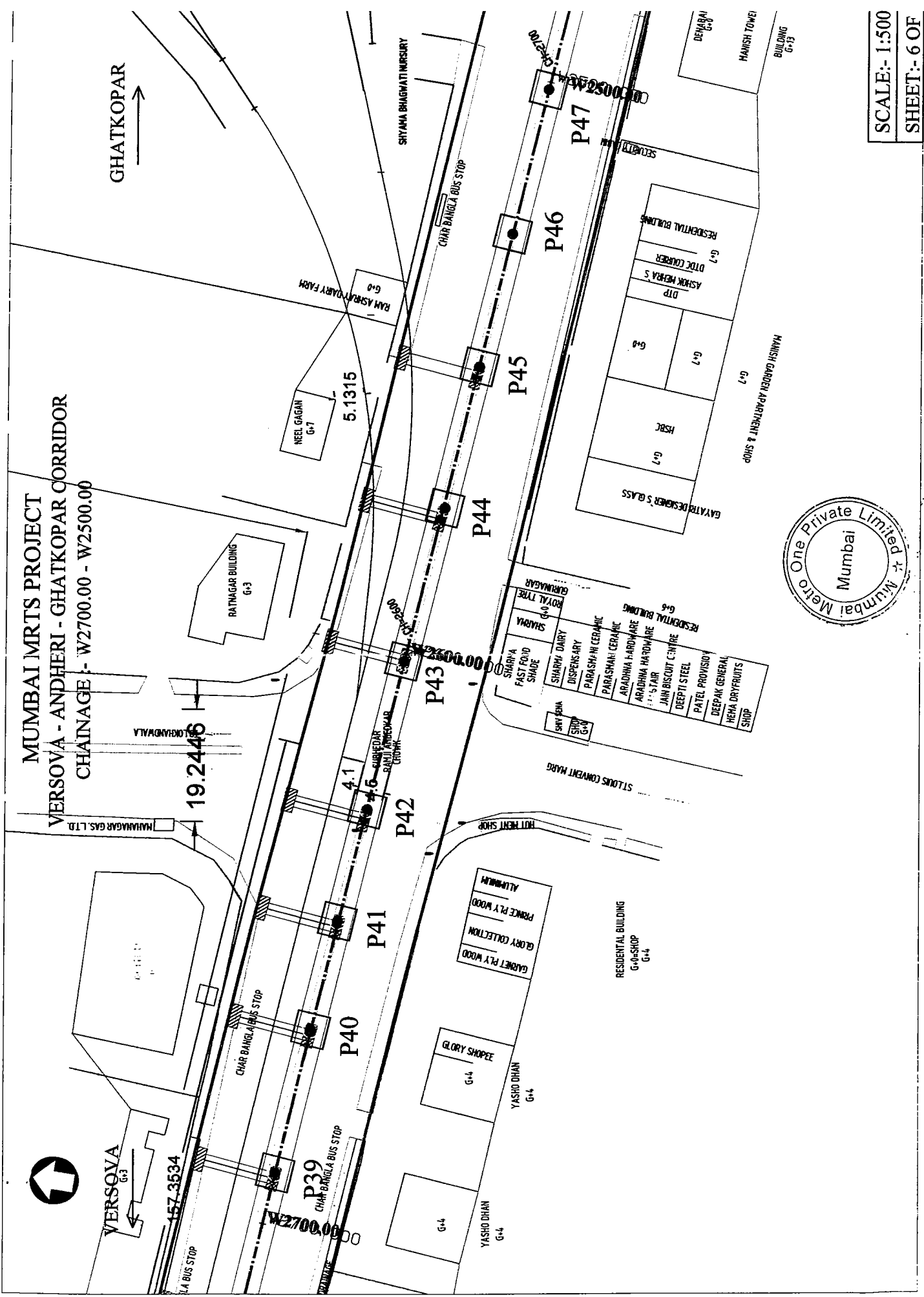

SCALE:- 1:500
 SHEET:- 6 OF

MUMBAI MRTS PROJECT
VERSOVA - ANDHERI - GHATKOPAR CORRIDOR
CHAINAGE :- W2100.00 - W1900.00



GHATKOPAR →

HP PETROL PUMP

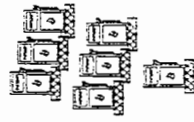

SHOKLA ESTATE AGENCY

TO SAHAKAR NAGAR

EVER SUN BUILDING
G+3

DR. SUBHASH D. BENDRE
 KRISHANK DAIRY
 DR. JINENDARA OZA
 GURUKRIPA ELECTRICALS
 NIT GENERAL STORES
 MRF TELAVANA TYER SERVICE
 MANOU JEWELLARS
 RAJPOOT DAIRY FARM
 G+0

OPEN COMPOUND

LOVELY MENS PARLOUR
 HOME LINKERS

OTTA

Chainage = 28483.384

Chainage = 28458.384

TL = 5.000

P62

P61

P60

P63

P64

P65

P66

P67

G+2
PANCHIVA

HUT SHOP

ROAD

HUT SHOP SUNIL FOOTWEAR

ADESH PLY & WOOD

CENTURY PLY & WOOD

STUDIO ORBIT

SAGAR MEDICAL

STAR

JAIN TRADERS

ROMA CERAMTICS

KAMAT STORES

OPEN PLOT

CO-OP HSG. SOC. LTD
DN NAGAR K-3

SHED

PLATFORM

G+4

PARKS

GLASS CONCEPTS

SHED

LINK ROAD

INDIAN OIL NAGAR
G+3

AGAR

VERSOVA ←

G+0

SHED

G+0

RESIDU.

G+0

W2100.00

W1900.00

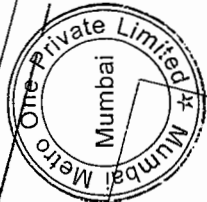

SCALE:- 1:500

SHEET:- 9 OF

MUMBAI MRTS PROJECT
VERSOVA - ANDHERI - GHATKOPAR CORRIDOR
CHAINAGE :- W1900.00 - W1700.00

GHATKOPAR →

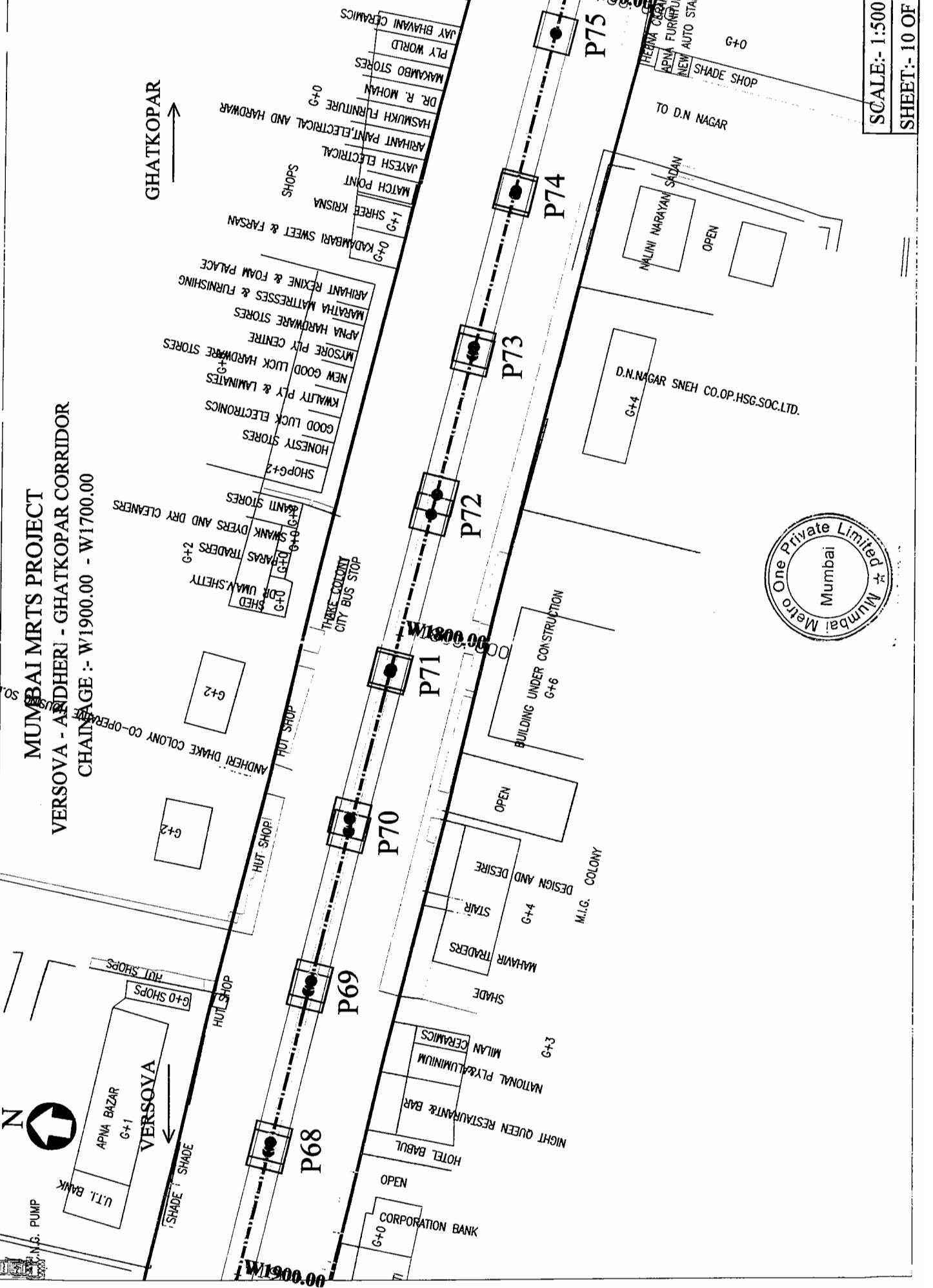
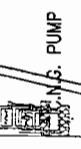

SCALE:- 1:500
 SHEET:- 10 OF



MUMBAI MRTS PROJECT
 VERSOVA ANDHERI - GHATKOPAR CORRIDOR
 CHAINAGE :- W1500.00 - W1300.00

AZADNAGAR STATION

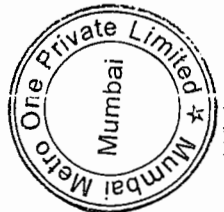
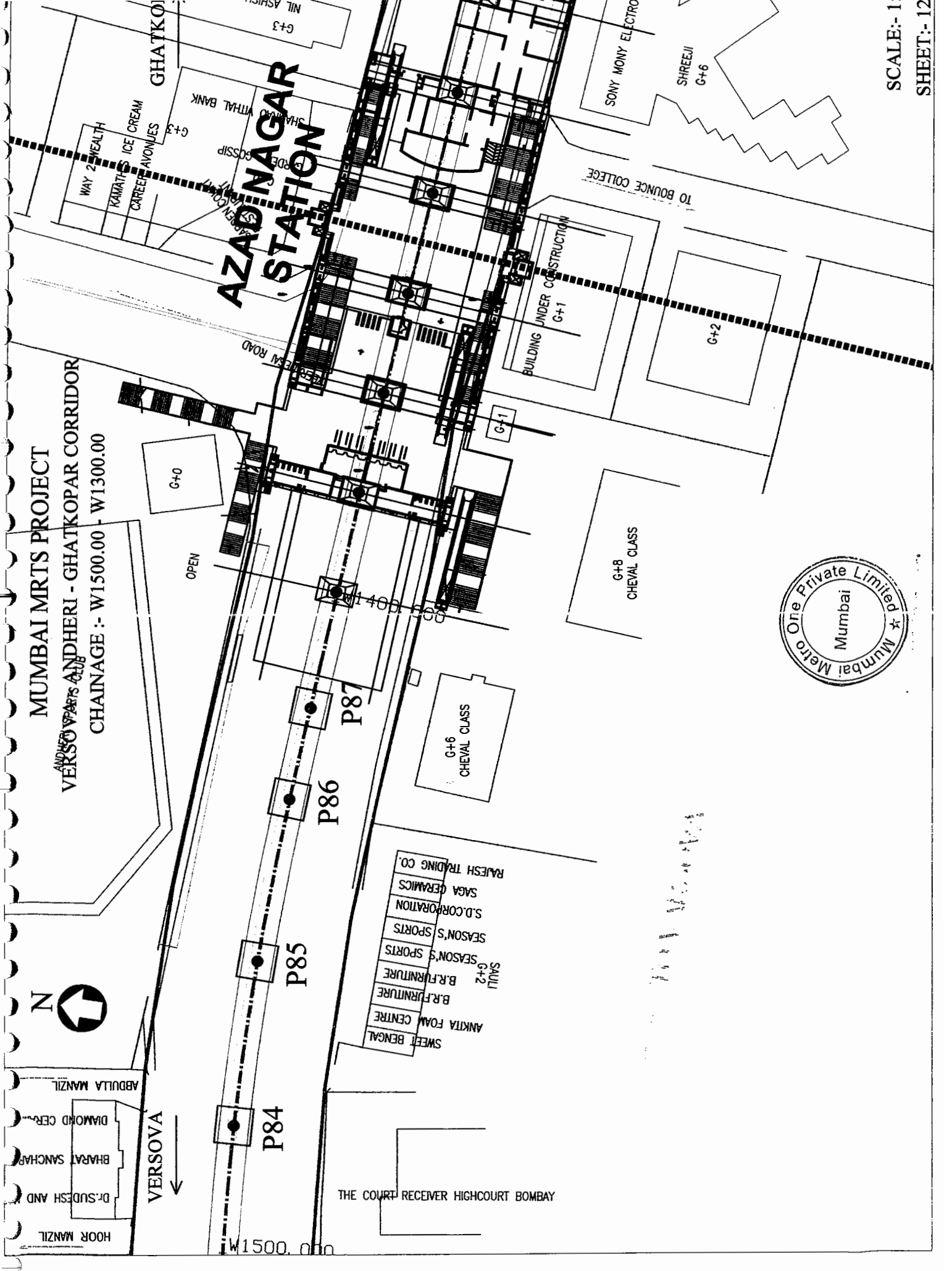

SCALE:- 1:
 SHEET:- 12

MUMBAI MRTS PROJECT

VERSOVA - ANDHERI - GHATKOPAR CORRIDOR
CHAINAGE :- W1100.00 - W900.00



VERSOVA

P96
000.001m
1100.000

P97

P98

P99

P100

P101

P102

P103

P104

SCALE:- 1/4
SHEET 14

OPEN

NIRMAL APARTMENT
G+4

WAND AND CO.
JANTA COLD DRINKS
ROYAL SWEET
HARSH CHANDRA CHANA BHANDAR

RESIDENTIAL
G+1

PATILPARE TRABHU HALL
G+2

ANAND APARTMENT
G+3

RESIDENTIAL BUILDING
G+2

YVCA ASHAKRAN APARTMENT
G+7

QUILLA
BAR AND GRILL
G+1

SUPER TIN WORK
SI KALPA ELECTRONICS
REKHA FERRICONS

RESIDENTIAL BUILDING
SHOP
G+0

PHILCO AUDIO CENTER
SHEETY AUTO ENTERPRISE
SHEED
LC OFFICE

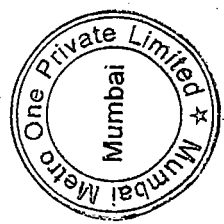



GHATKOPAR
→

←
VERSOVA

MUMBAI METRO PROJECT
VERSOVA AND HERRI - GHATKOPAR CORRIDOR
CHANGING W900.00 - W700.00

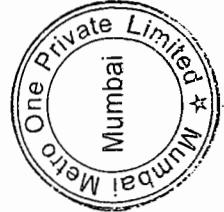
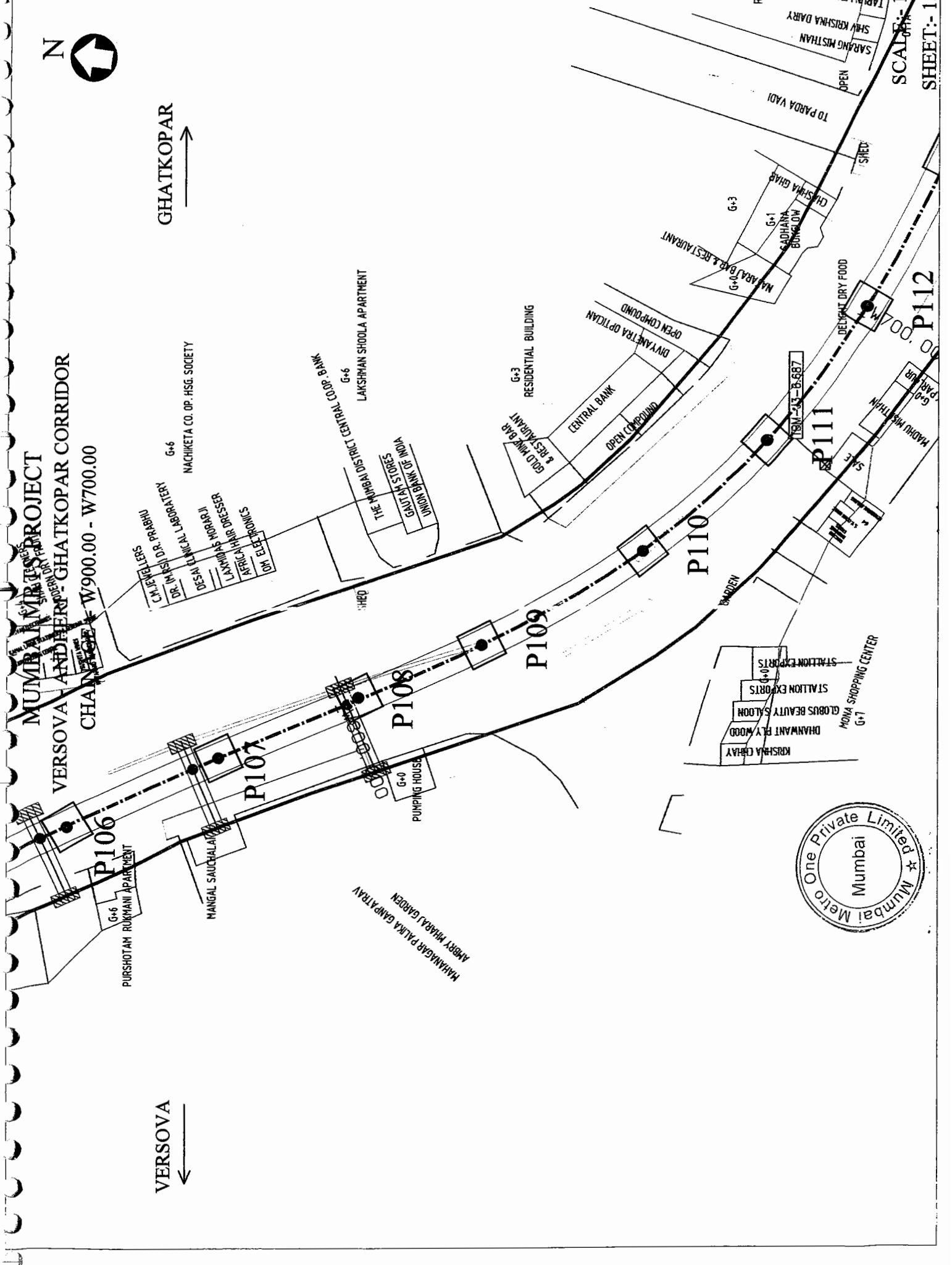

SCALES: 1:1000
SHEET: 15

MUMBAI MRTS PROJECT
 VERSOVA - ANDHERI - GHATKOPAR CORRIDOR
 CHAINAGE :- E500.00 - E700.00



GHATKOPAR
 →

←
 VERSOVA

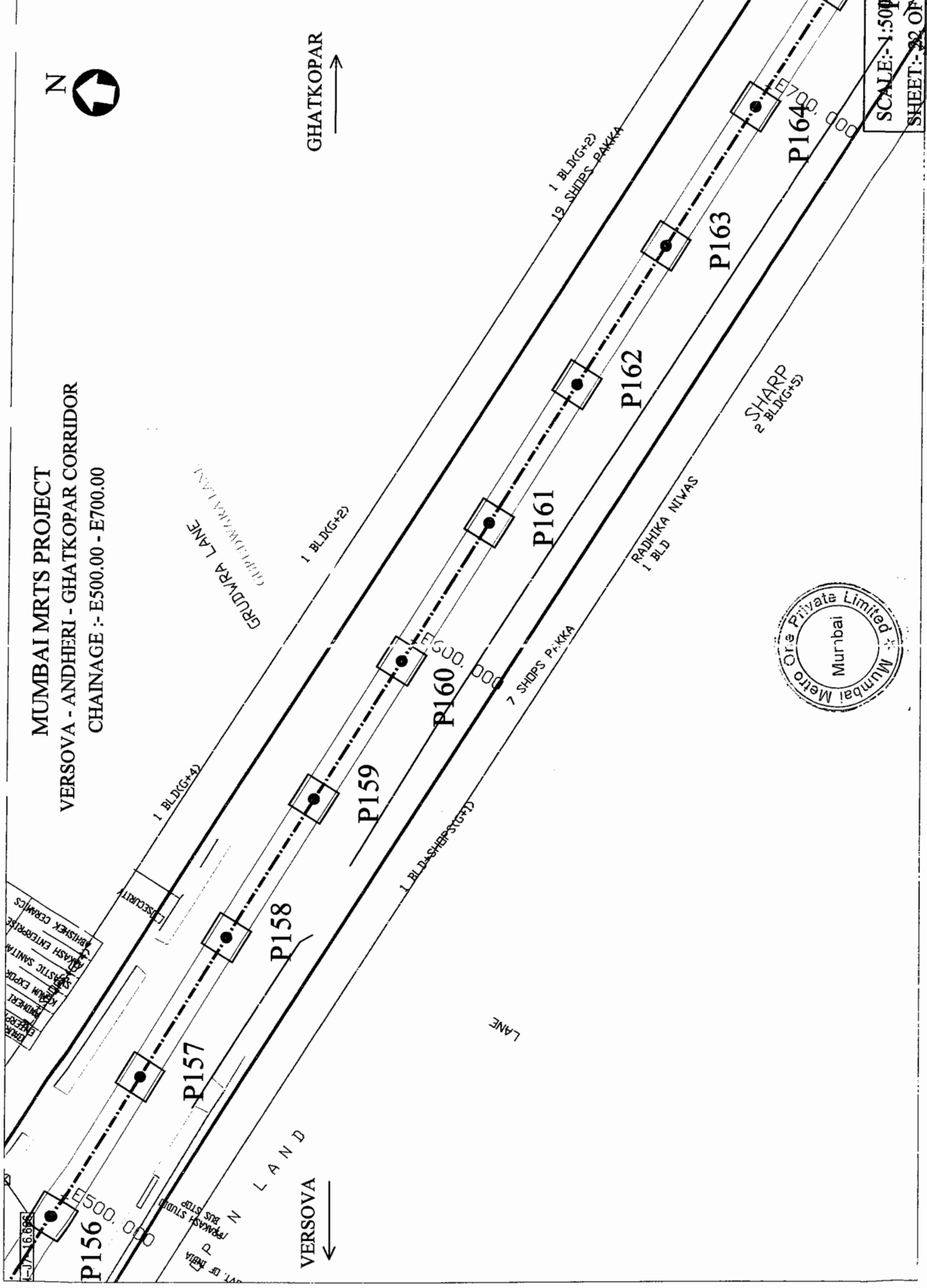

SCALE:- 1:500
 SHEET:- 22 OF

MUMBAI MRTS PROJECT
VERSOVA - ANDHERI - GHATKOPAR CORRIDOR
CHAINAGE :- E700.00 - E900.00



GHATKOPAR
→

←
VERSOVA

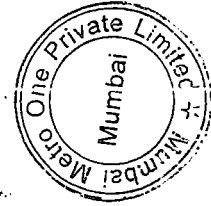
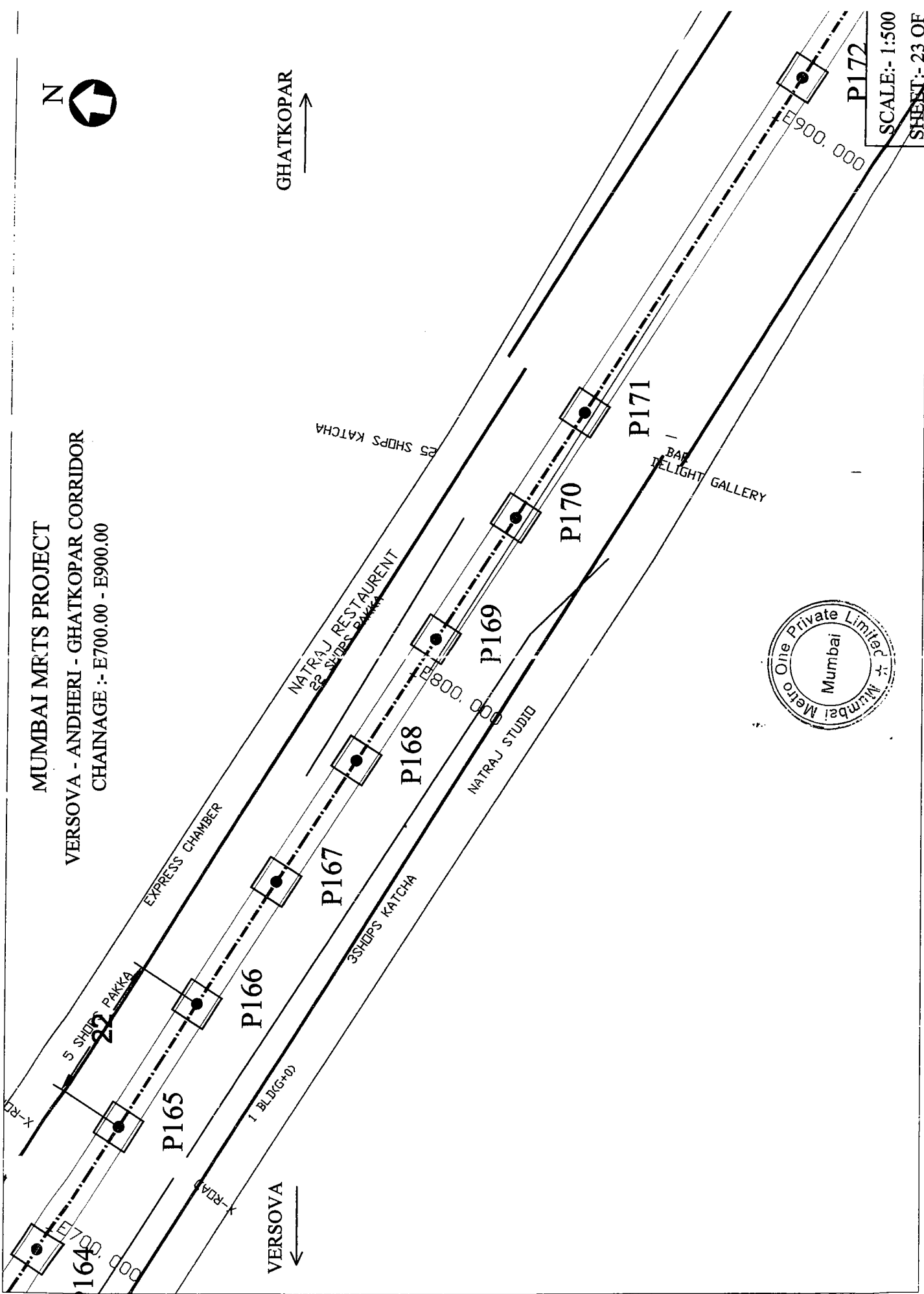

P172
SCALE:- 1:500
SHEET:- 23 OF



GHATKOPAR
→

←
VERSOVA

MUMBAI MRTS PROJECT
VERSOVA - ANDHERI - GHATKOPAR CORRIDOR
CHAINAGE :- E900.00 - E1100.00

WEH STATION

PETROL PUMP

SERVICE ROAD

SADANA RESTORANT & BAR

MAHARAJA BAR

10 SHOPS PAKKA

6 SHOPS PAKKA

SHIKHANYALA

20.71

P175

P174

P173

P172

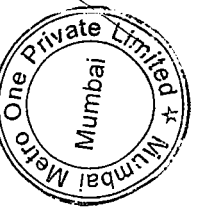

P176
SCALE:- 1:500
SHEET:- 24 OF

E 900.000

E 1100.000

MUMBAI MRTS PROJECT

VERSOVA - ANDHERI - GHATKOPAR CORRIDOR

CHAINAGE :- E1100.00 - E1300.00

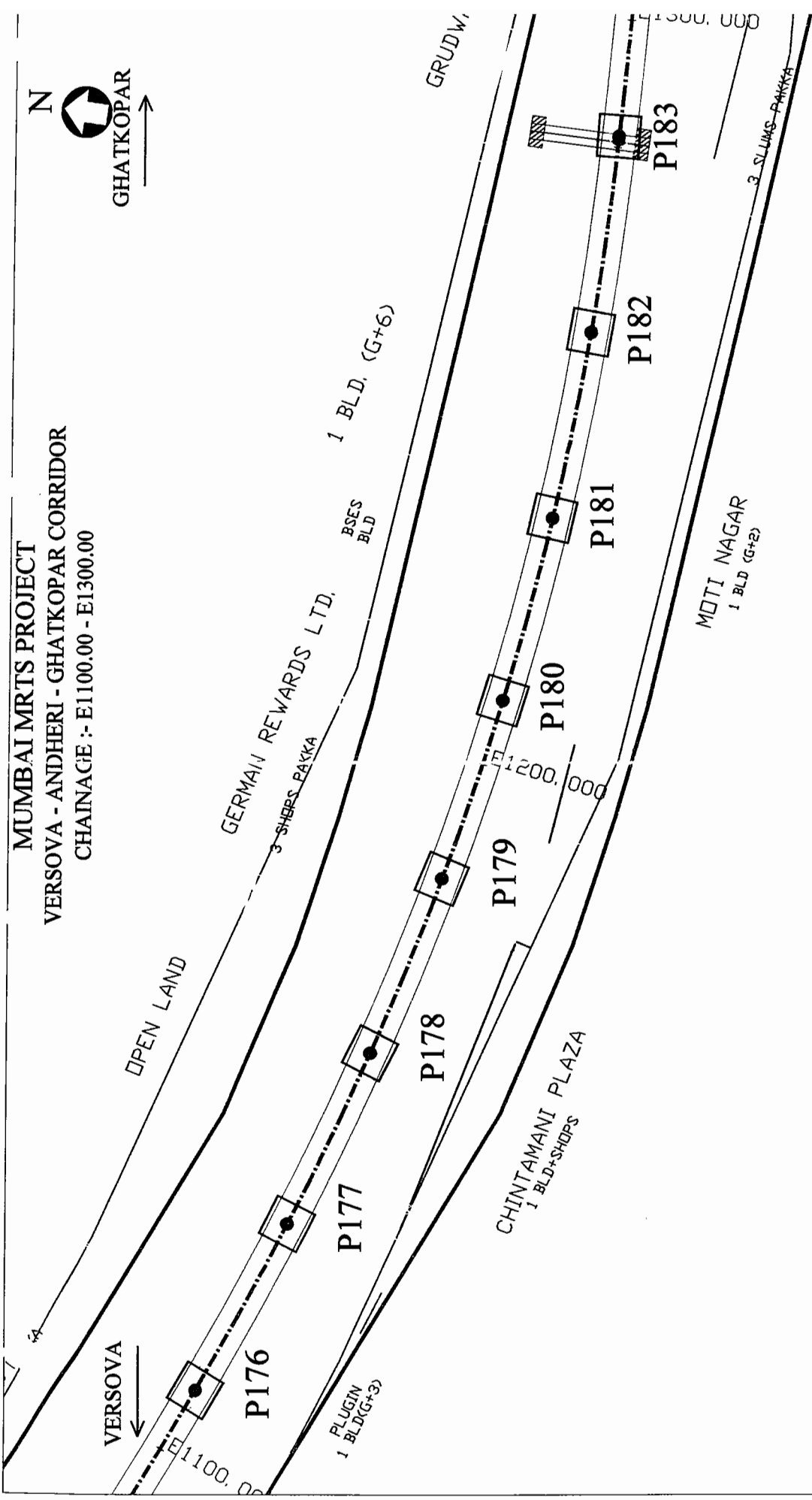

SCALE:- 1:500
SHEET:- 25 OF

MUMBAI MRT'S PROJECT
VERSOVA - ANDHERI - GHATKOPAR CORRIDOR
CHAINAGE :- E1300.00 - E1500.00



VERSOVA ←

1 BLD. (G+6)
6 SHOPS

NALLAY GARDAN
1 BLD. (G+3)

MARIA KIRPAPURN CHURCH

1 BLD.(G+3)

MAHA KALI GURFA ROAD

← GHATKOPAR
20 SHOPS PAKKA

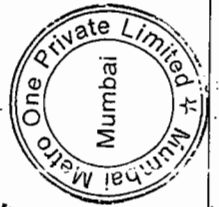
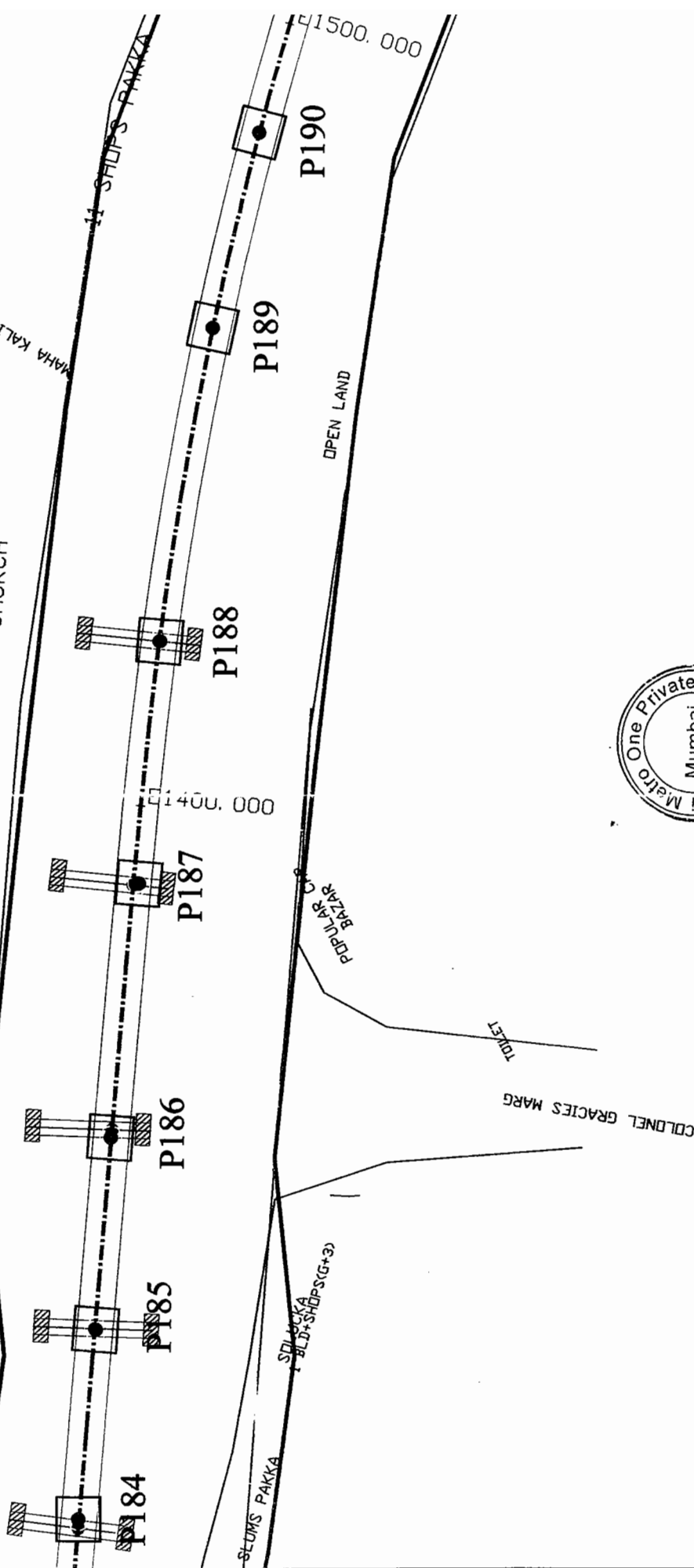

MUMBAI MRTS PROJECT
VERSOVA - ANDHERI - GHATKOPAR CORRIDOR
CHAINAGE :- E1500.00 - E1700.00

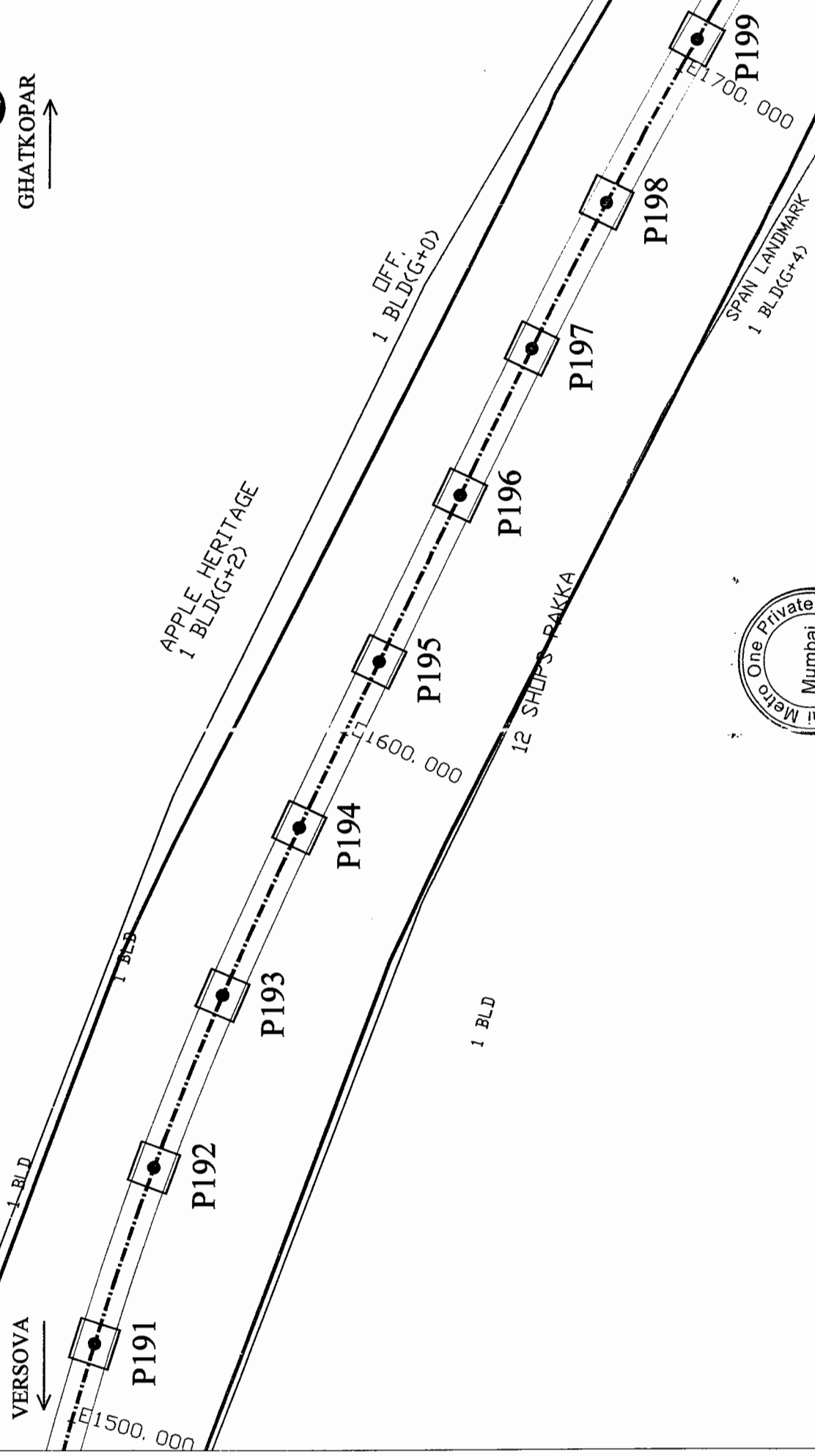

SCALE:- 1:500
SHEET:- 27 OF

MUMBAI MRTS PROJECT
VERSOVA - ANDHERI - GHATKOPAR CORRIDOR
CHAINAGE :- E1700.00 - E1900.00



GHATKOPAR
→

VERSOVA
←

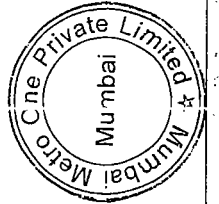
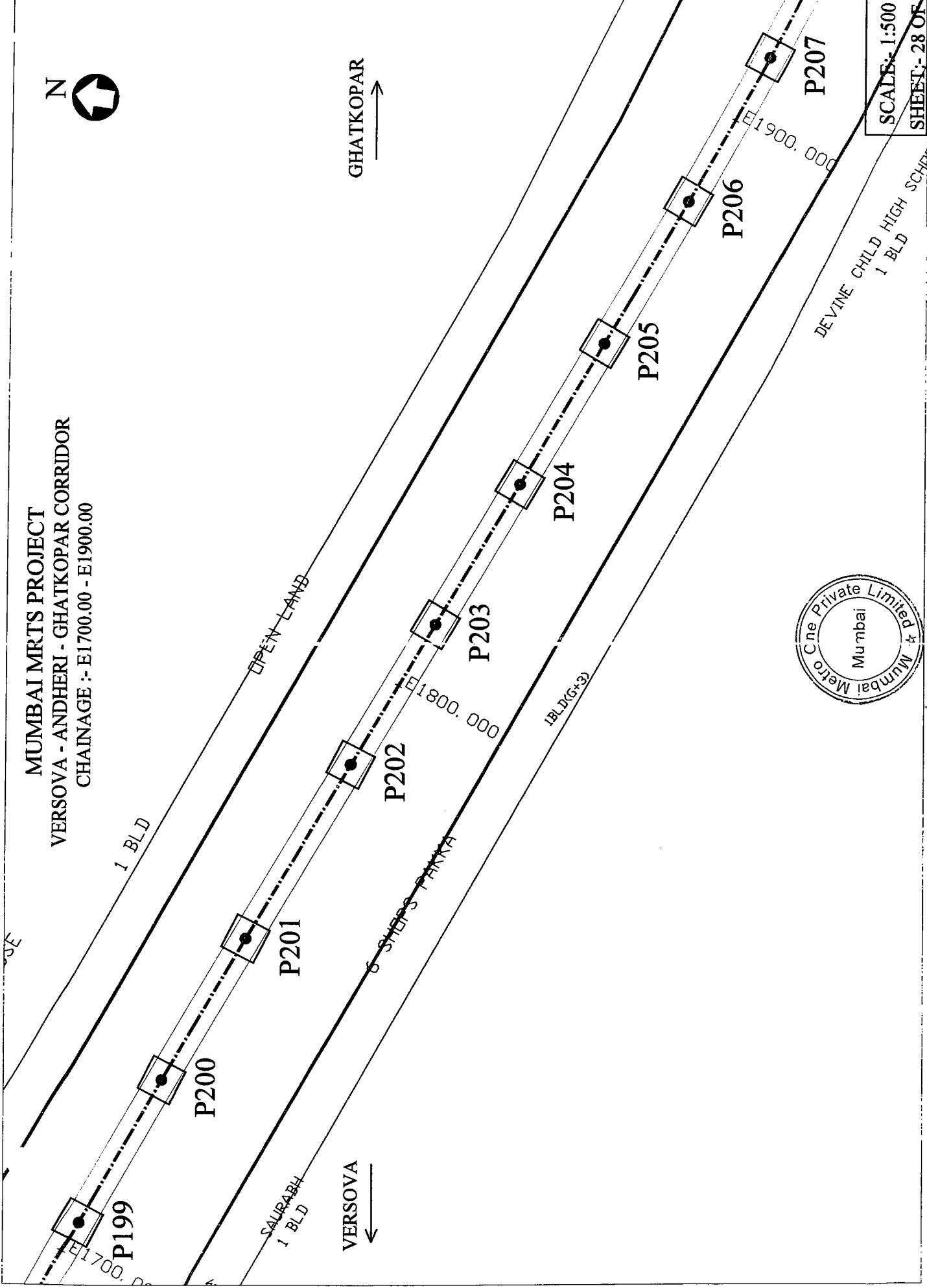

SCALE:- 1:500
SHEET:- 28 OF

DEVINE CHILD HIGH SCHOOL
1 BLD

1 BLD

OPEN LAND

E1800.000

E1900.000

1BLD(G+3)

6 STEPS PAKKA

SALURABH
1 BLD

MUMBAI MRTS PROJECT
VERSOVA - ANDHERI - GHATKOPAR CORRIDOR
CHAINAGE :- E1900.00 - E2100.00



GHATKOPAR
→

VERSOVA
←

THE HIMALAYA
DRUGS CO. LTD.
1 BLD

CENTURY MECHANICAL
SYSTEM (I) P. LTD.
1 BLD

ACME PLAZA
1 BLD

P209

P210

P211

P212

P213

P214

E1900

1 BLD

1 BLD

1 BLD

SANJAM TALKIJ
1BLD

E2100.000



SCALE:- 1:500
SHEET:- 29 OF

MUMBAI MRTS PROJECT
VERSOVA - ANDHERI - GHATKOPAR CORRIDOR
CHAINAGE :- E1900.00 - E2100.00



VERSOVA
←

GHATKOPAR
→

BLANK SHEET



SCALE:- 1:500
SHEET:- 30 OF

MUMBAI MRTS PROJECT
VERSOVA - ANDHERI - GHATKOPAR CORRIDOR
CHAINAGE :- E2100.00 - E2300.00



GHATKOPAR
→

VERSOVA
←

PARK

* SHEEPS PAKKA

1 BLD+SHOPS

OPEN

CHAKALA STATION

P215

P216

P217

P218

P219

P220

OPEN LAND

200.000

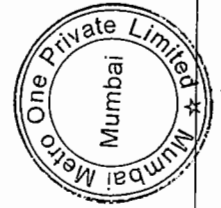
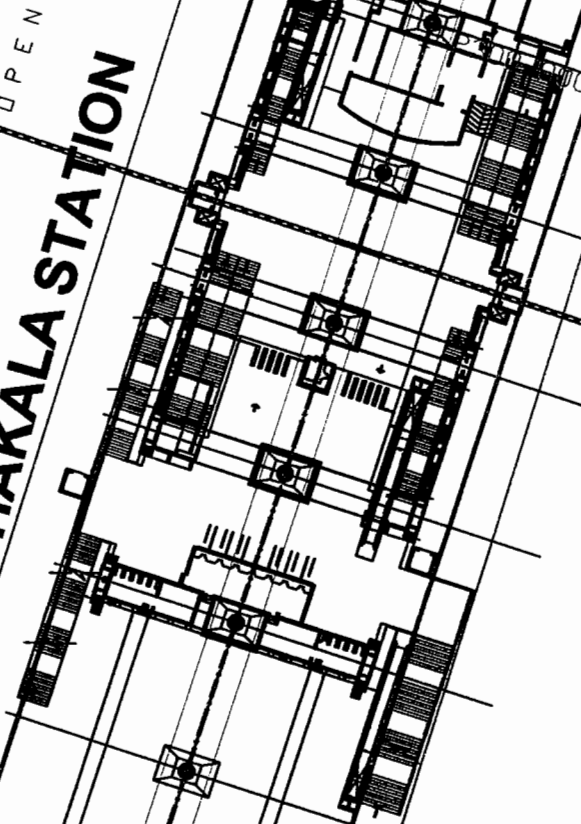

SCALE:- 1:500

SHEET:- 31 OF 6

MUMBAI MRTS PROJECT
VERSOVA - ANDHERI - GHATKOPAR CORRIDOR
CHAINAGE :- E2500.00 - E2700.00



VERSOVA
←

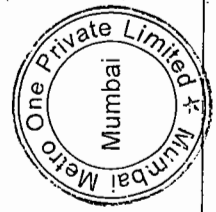
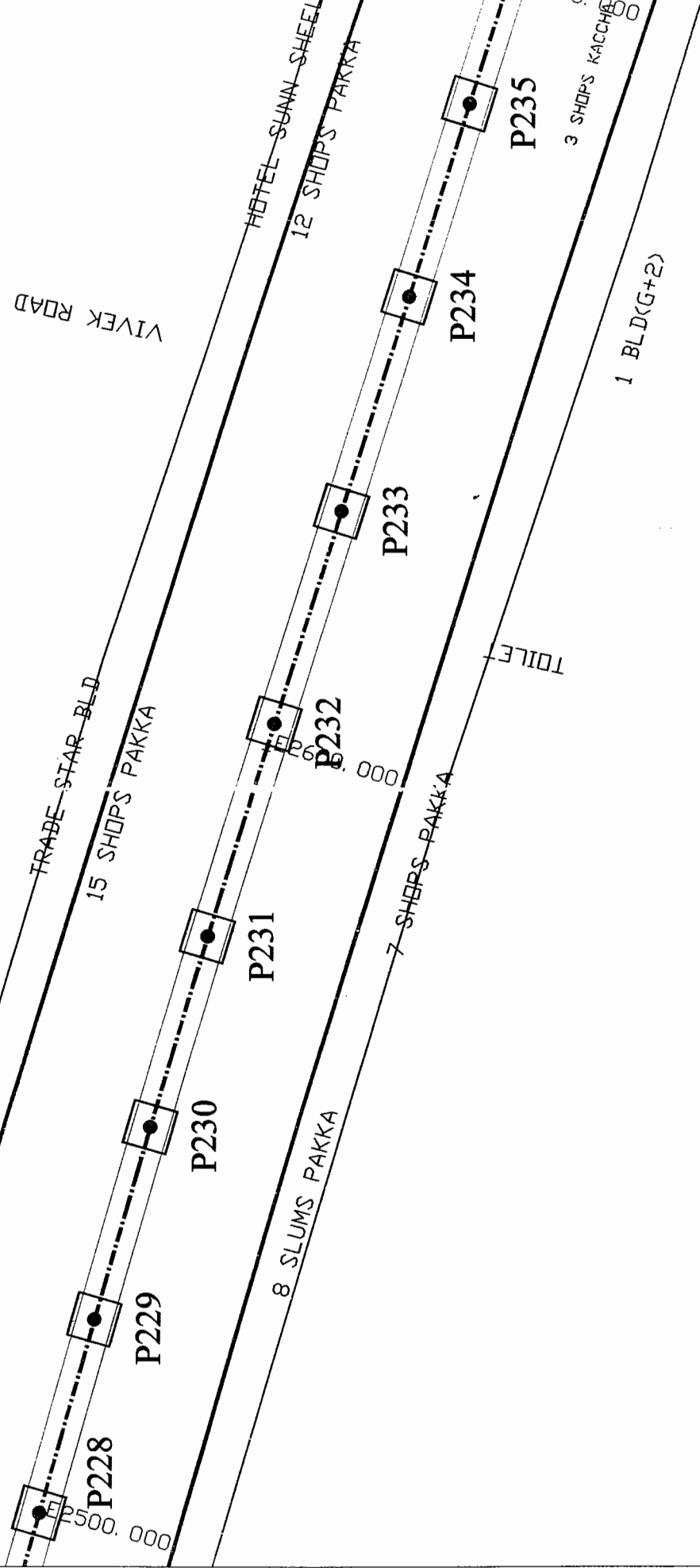

MUMBAI MRTS PROJECT
VERSOVA - ANDHERJ - GHATKOPAR CORRIDOR
CHAINAGE :- E2900.00 - E3100.00



VERSOVA
←

GHATKOPAR
→

AIR PORT ROAD

9 SHOPS PAKKA

1 SHOPS PAKKA

CHARCH ROAD

1 BLD

THE LEELA HOTEL 1 BLD

1 SLUMS

1 LAND

PETROL PUMP

E2900.00

E3100.00

P244

P245

P246

P247

P248



THE LEELA GALLE

SCALE:- 1:500

SHEET:- 35 OF 1

MUMBAI MRTS PROJECT
VERSOVA - ANDHERI - GHATKOPAR CORRIDOR
CHAINAGE :- E3100.00 - E3300.00



GHATKOPAR
→

MAX BLUE
1 BLD

VERSOVA
←

KUMARIA PRESIDENCY HOTEL
1 BLD

BUS STOP

OPEN LAND

SHOP

1 SHOPS

8 SHOPS PACCA

13 SHOPS PACCA

E3100.000
P248

P249

P250

P251

P252

P253

P254

P255

P256
E3300.000

AIRPORT
JUNCTION



LAND

7 SHOPS
SCALE:- 1:500
SHEET:- 36 OF

MUMBAI MRTS PROJECT
VERSOVA - ANDHERI - GHATKOPAR CORRIDOR
CHAINAGE :- E3300.00 - E3500.00



GHATKOPAR
↑

1 BLDG+4)
MARDL FIRE STATION

TANK

MINI SHOPS

TOILET

BUS STOP

3 SHOPS PACCA

X-ROAD

2 SHOPS PACCA

PETROL PUMP

OPEN LAND



SCALE:- 1:500
SHEET:- 37 OF 5

NALA

VERSOVA
↓

17 SHOPS PACCA

P257

DPS PACCA

P258

P259

OPEN LAND

P260

BUS STOP

P261

BUS STOP

P262

P263

P264

E3500.000

E3300.000

E3400.000

UMBAI MRTS PROJECT
VERSOVA - ANDHERI - GHATKOPAR CORRIDOR
CHAINAGE :- E3700.00 - E3900.00



GHATKOPAR



VERSOVA
SM CENTRE

PARK
BUS STOP

PETROL PUMP

X-ROAD

1 BLD(G+2)

CANARA ROBBE JNDUSTRI
1 BLD

P271

P272

BUS STOP

P273

P274

P275

P276

P277

5 SHOPS KACCHA

SHOP

SANJAY BLDG
1BLD(G+2)

X-ROAD

NANKER CHANBERS

I LAND

CHADE

MU IBAI MRTS PROJECT
VERSOVA - ANDHERI - GHATKOPAR CORRIDOR
CHAINAGE :- E3900.00 - 4100.00



1 BLD (G+0)

VERSOVA
←

SEAM
1 BLD

X-ROAD

OPEN ROAD

OPEN LAND

BUS STOP

MITSUBISHI MOTORS

BUS STOP

P278

P279

P280

P281

P282

P283

I LAND

MITAL ESTATE
1 BLD+SHOPS

P284

P285

E3900.000

4000.000

100.000

BANK
1 BLD (G+5)





GHATKOPAR
→

MUMBAI MRTS PROJECT
VERSOVA - ANDHERI - GHATKOPAR CORRIDOR
CHAINAGE :- E4100.00 - E4300.00

MITHI RIVER

H.KANTILAL&CO
1 BLD(G+3)

BUS STOP

P293

P292

P291

P290
E4200.000

P289

P288

P287

P286
E4100.000

VERSOVA
←

MITHI RIVER

2 SHIPS KACCHA

S.M.D.VRINDJI MARG

MATHELEXMI GARIJAN BAR



STP



GHATKOPAR
→

MUMBAI MRTS PROJECT
VERSOVA - ANDHERI - GHATKOPAR CORRIDOR
CHAINAGE :- E4300.00 - E4500.00

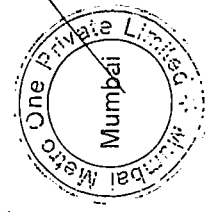
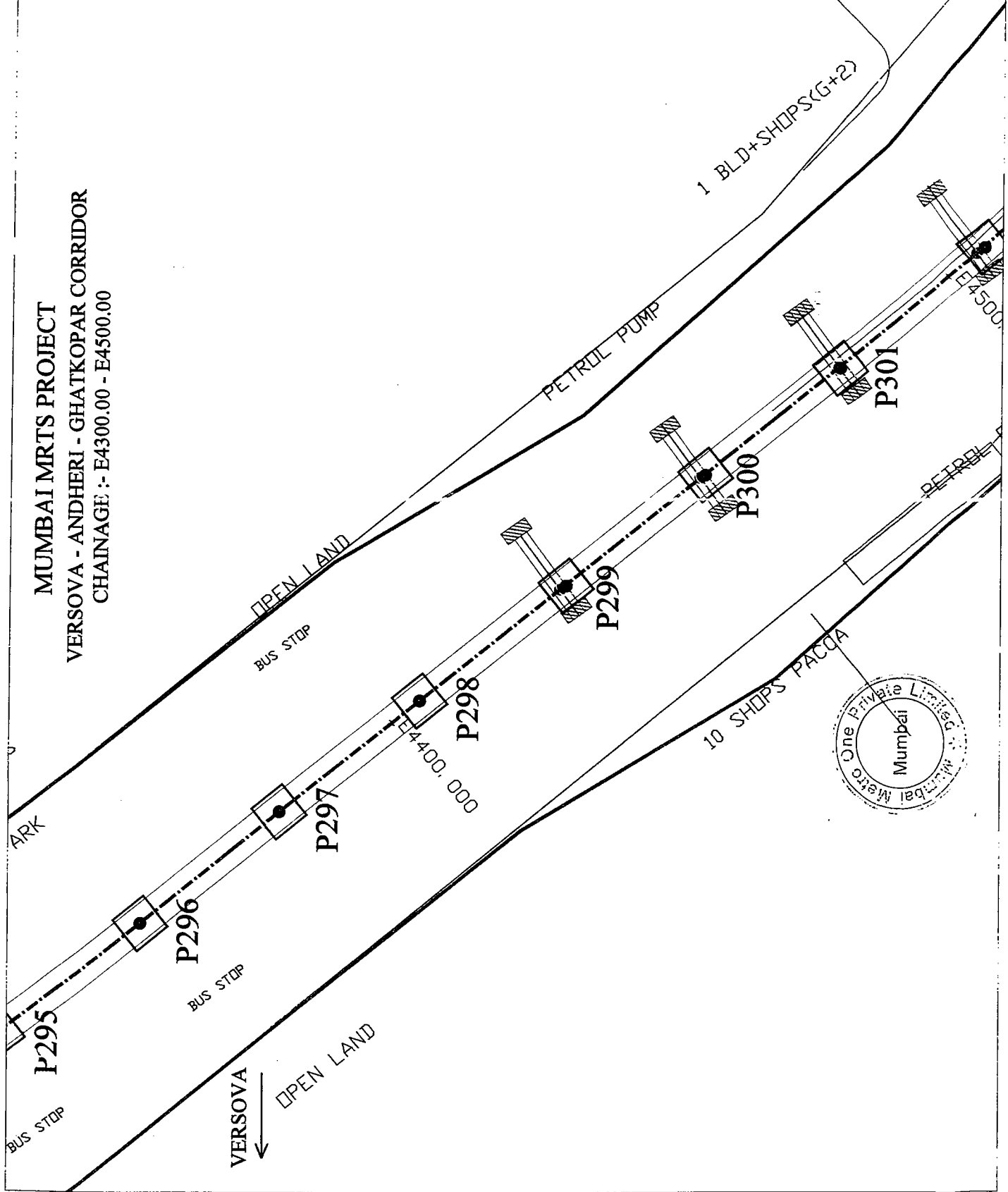

NEEL KA

ARK

BUS STOP

VERSOVA
←

BUS STOP

BUS STOP

OPEN LAND

OPEN LAND

PETROL PUMP

1 BLD+SHOPS(G+2)

10 SHEEPS PACCA

P295

P296

P297

P298

P299

P300

P301

E4400.00

E4500.00

MUMBAI MRTS PROJECT
VERSOVA - ANDHERI - GHATKOPAR CORRIDOR
CHAINAGE: E4500.00 - E4700.00

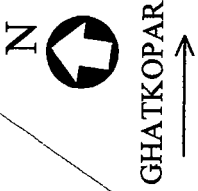

SAKINAKA STATION

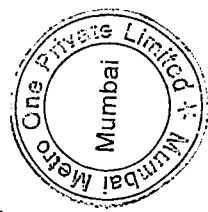
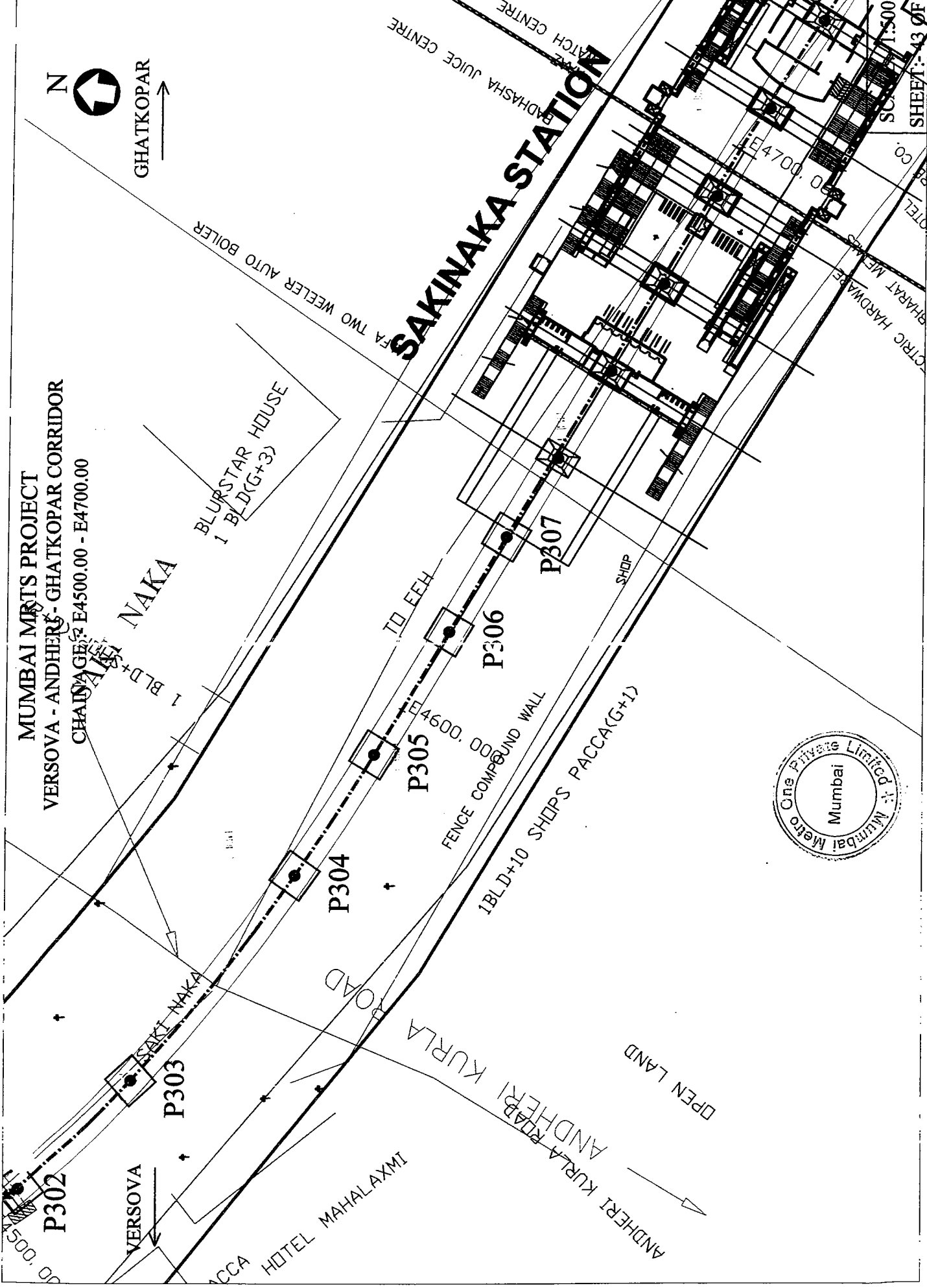



GHATKOPAR

SCALE:- 1:500
SHEET:- 45 OF

MUMBAI MRTS PROJECT
VERSOVA - ANDHERI - GHATKOPAR CORRIDOR
CHAINAGE :- E4900.00 - E5100.00

BABUJI TONER SHOP
PAYAL ELECTRICALS SHOP

MALAYKA
SHETTY MOTORS
DIAMOND COUNTRY BAR
SHRI KRISHNA HOTEL
IMPERIAL TRADERS
BK ENTERPRISES
SHRI DENI CHINESE SHOPS
KOKANI POULTRY FARMS
1.5 NALA

SHRIS GENERAL STORES
DIAMOND MUTTON SHOP
ANSAR GENERAL STORES
SHOPS GALLI
REX JEANS
ARTI VEDIO SHOP
KGN MATTRESSES
GENERAL STORE
TAPOR TYRES
SHOPS
SHOPS

P319

P318

P317

P316

P315

P314

VERSOVA

AMS & CO.

SAUTYOJI SCHOOL

SHIV PRASAD

HARI PRASAD UUPI RESTAURANT
LOKMANYA TILAK NAGAR GOLD GYMNASIUM
JAGNATH TRANSPORT
SHOPS



P320

P321

P322

P323

P324

P325

P326

P327

P328

000.00

000.00000

00.00150

00.00150

00.00150

00.00150

00.00150

00.00150

00.00150

00.00150

00.00150



MUMBAI METRO PROJECT
 VERSOVA - ANDHERI - GHATKOPAR CORRIDOR
 CONTRACT NO. - E5100.00 - E5300.00
 CONTRACT VALUE :- E5100.00 - E5300.00

DHANLAXMI
 CO. OP. HSG
 SCALE: 1:500
 SHEET: - 480F

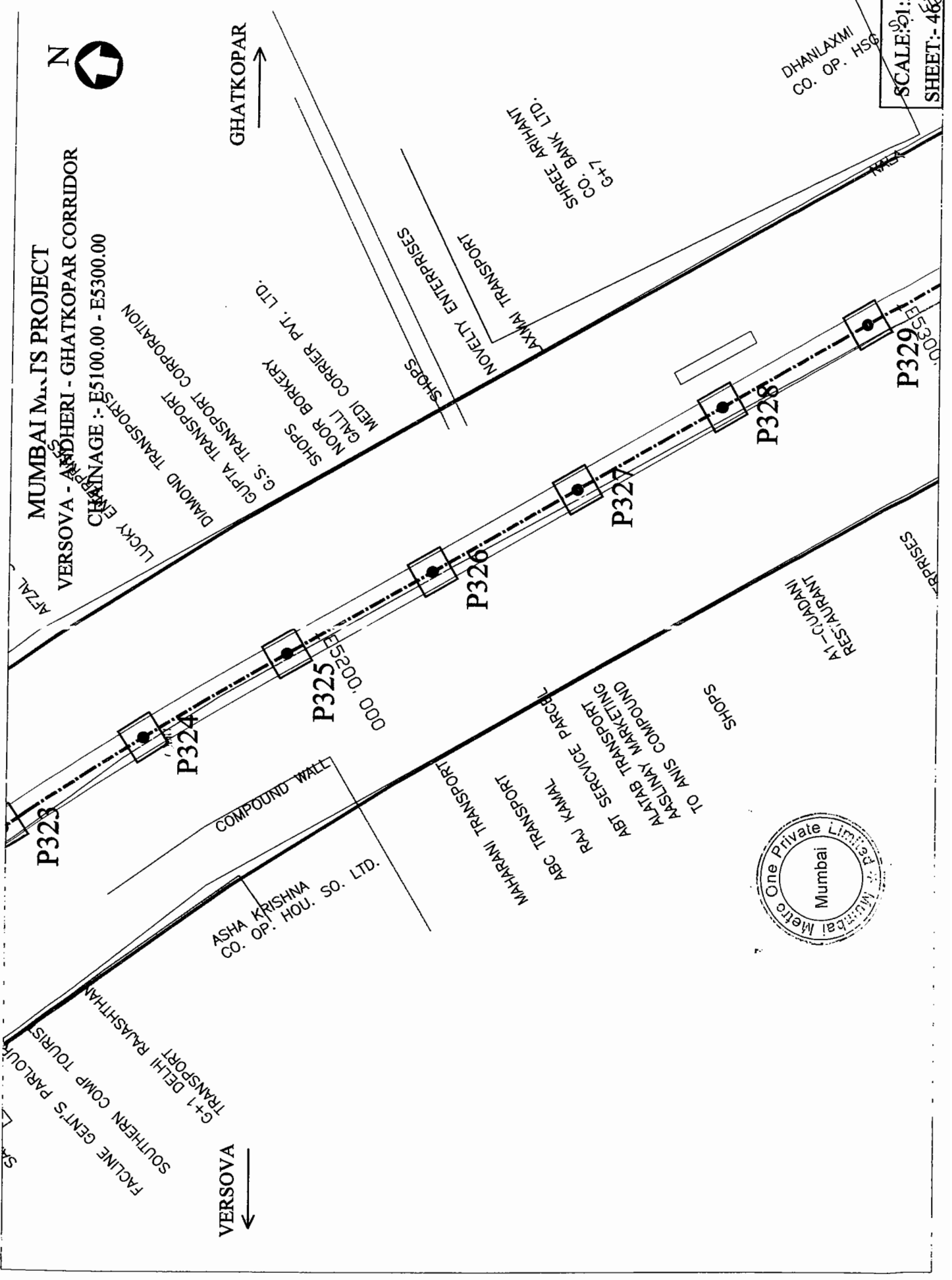



GHATKOPAR
↑

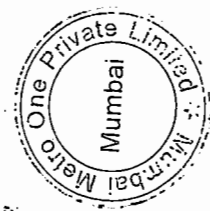

SCALE:- 1:500
SHEET:- 47 OF 6

MUMBAI MRTS PROJECT
VERSOVA - ANDHERI - GHATKOPAR CORRIDOR
CHAINAGE :- E5300.00 - E5400.00

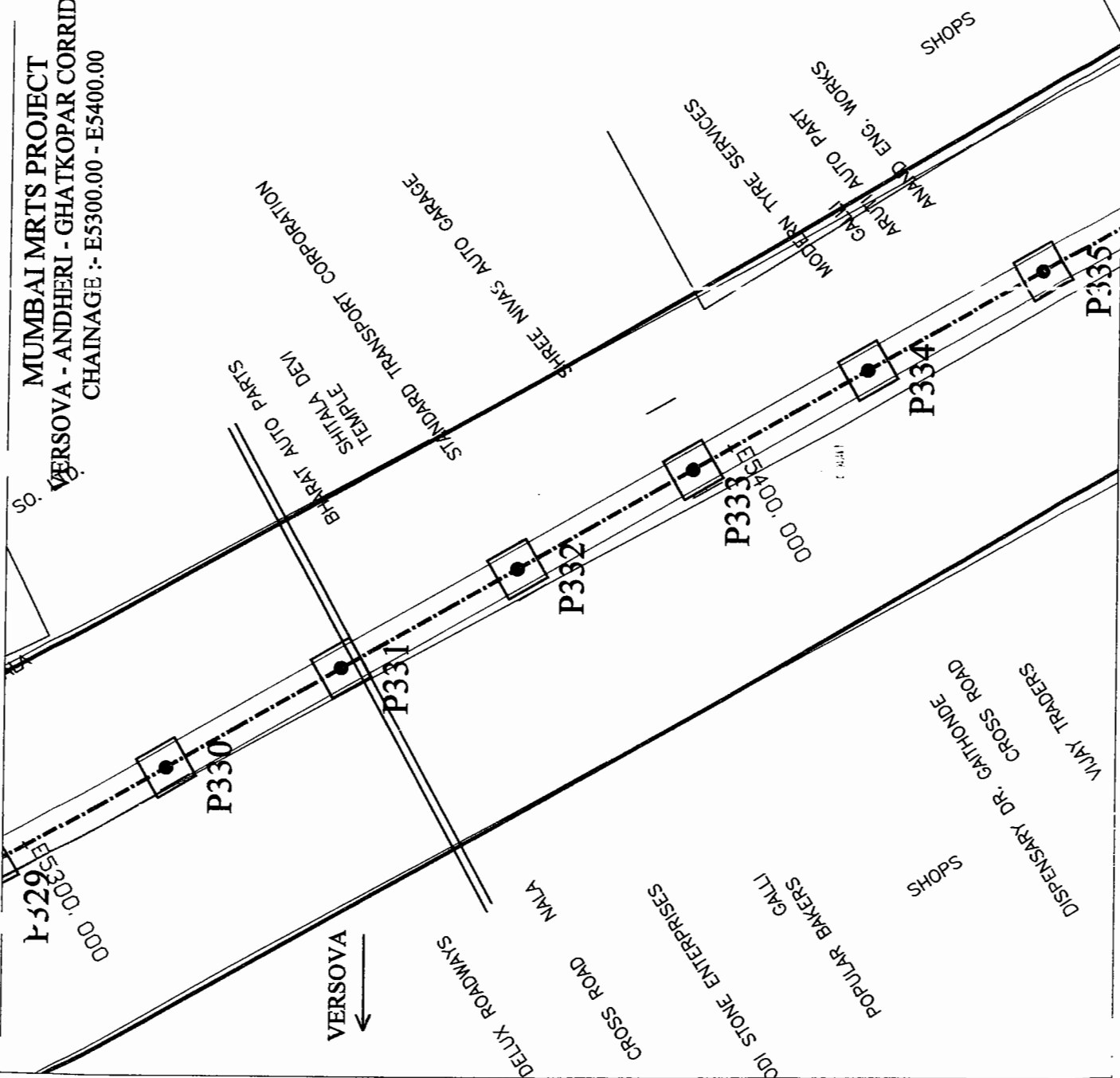

SOCIETY

SIS

SDOHS

ANAND ENG. WORKS
ARJUN AUTO PART
GALLI
MODERN TYRE SERVICES

SHREE NNAS AUTO GARAGE

STANDARD TRANSPORT CORPORATION
SHITALA DEVI TEMPLE
BHARAT AUTO PARTS

E5300.00

E5400.00

VERSOVA
↓

DELUX ROADWAYS
CROSS ROAD MALA

ODI STONE ENTERPRISES
POPULAR BAKERS GALLI

DISPENSARY DR. GATHONDE
CROSS ROAD
VIJAY TRADERS

SDOHS

P335

P334

P333

P332

P331

P330



GHATKOPAR
↑

↓
VERSOVA

MUMBAI MRTS PROJECT
VERSOVA - ANDHERI - GHATKOPAR CORRIDOR
CHAINAGE :- E5400.00 - E5600.00

JTU AUTO PARTS
SHIV GOURAV HOUS.
SHREE NNAS ROAD LINES

P336

P337

P338

P339

P340

P341

P342

ADHARSH STEEL WELDING

PATEL MOTAR TRAINING SCHOOL

SAI SAGAR BATTERY

PREM SAGAR BATTERY

VILA ENTERPRISES

RATAN GLASS CENTER



SCALE: 1:50
SHEET- 48 OF 50

SHREE PUA BAR & RESTAURANT
D. SILVA BAUG
DELHI PUNJAB GOODS
CARRIERS PVT. LTD.

CT MACHINE
SHIV AUTO PARTS
TO PARTS
GATE

MUMBAI MRTS PROJECT
VERSOVA & ANDHERI - GHATKOPAR CORRIDOR
CHAINAGE :- E:5600.00 - E:5800.00



GHATKOPAR
→

SCALE: 1:500
SHEET: 10/50

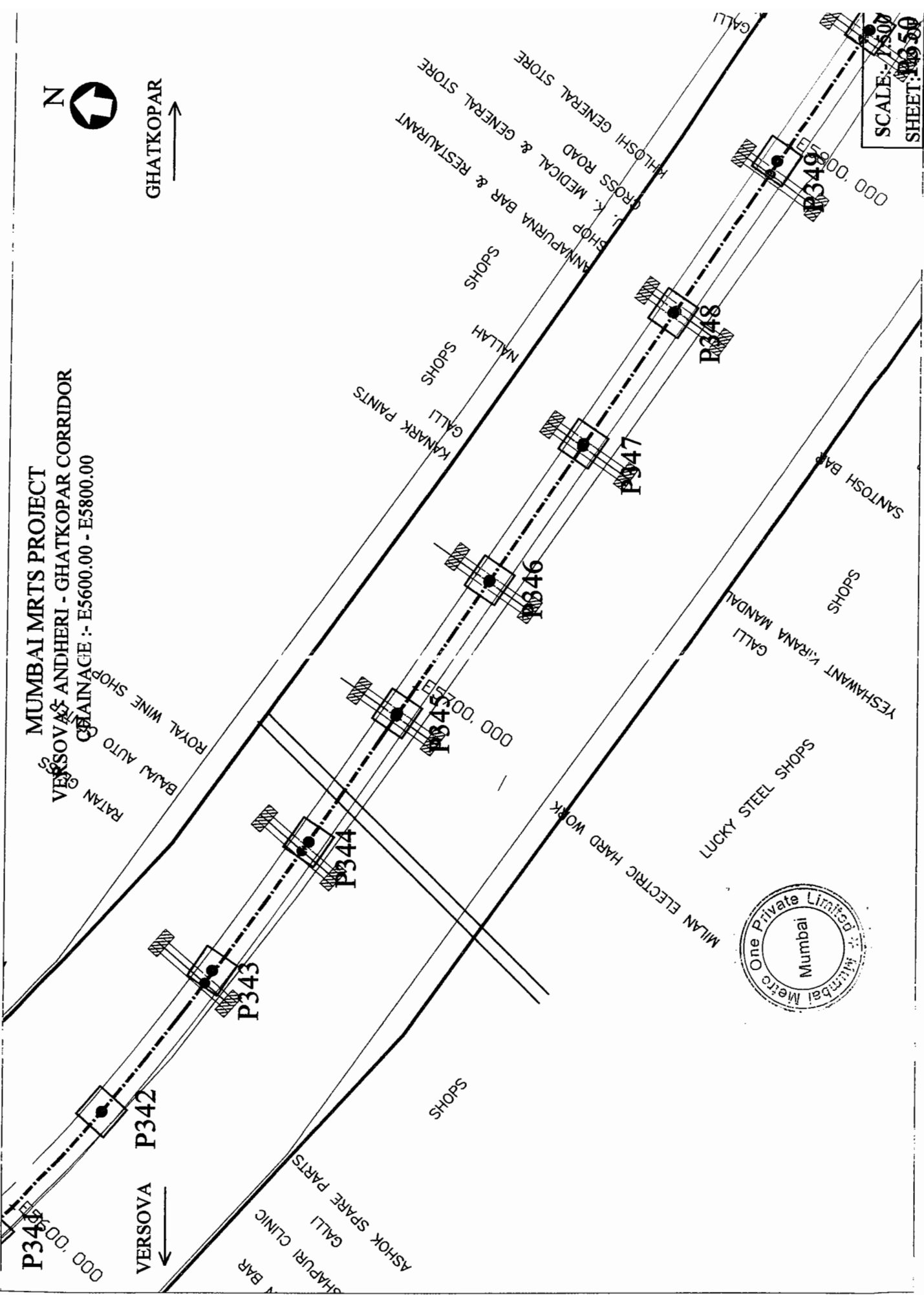

P342
000.00500

VERSOVA
←

SHAPURI CLINIC
GALLI
ASHOK SPARE PARTS
GALLI

SHOPS

P343

RATAN GOSWAMI
BAJAJ AUTO
ROYAL WINE SHOP

P344

MIAN ELECTRIC HARD WORK
LUCKY STEEL SHOPS

YESHWANT KIRANA MANDAL
GALLI

SHOPS

SANTOSH BAR

P347

KANARK PAINTS
GALLI

NALLAH
SHOPS

P348

ANNAPURNA BAR & RESTAURANT
SHOP
J. K. MEDICAL & GENERAL STORE
GROSS ROAD
KHLOSHI GENERAL STORE

GALLI

P349

000.00500



GHATKOPAR



MUMBAI MRTS PROJECT
VERSOVA - ANDHERI - GHATKOPAR CORRIDOR
CHAINAGE :- E5800.00 - E6000.00

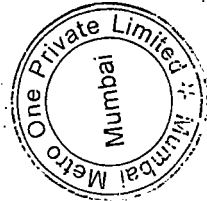
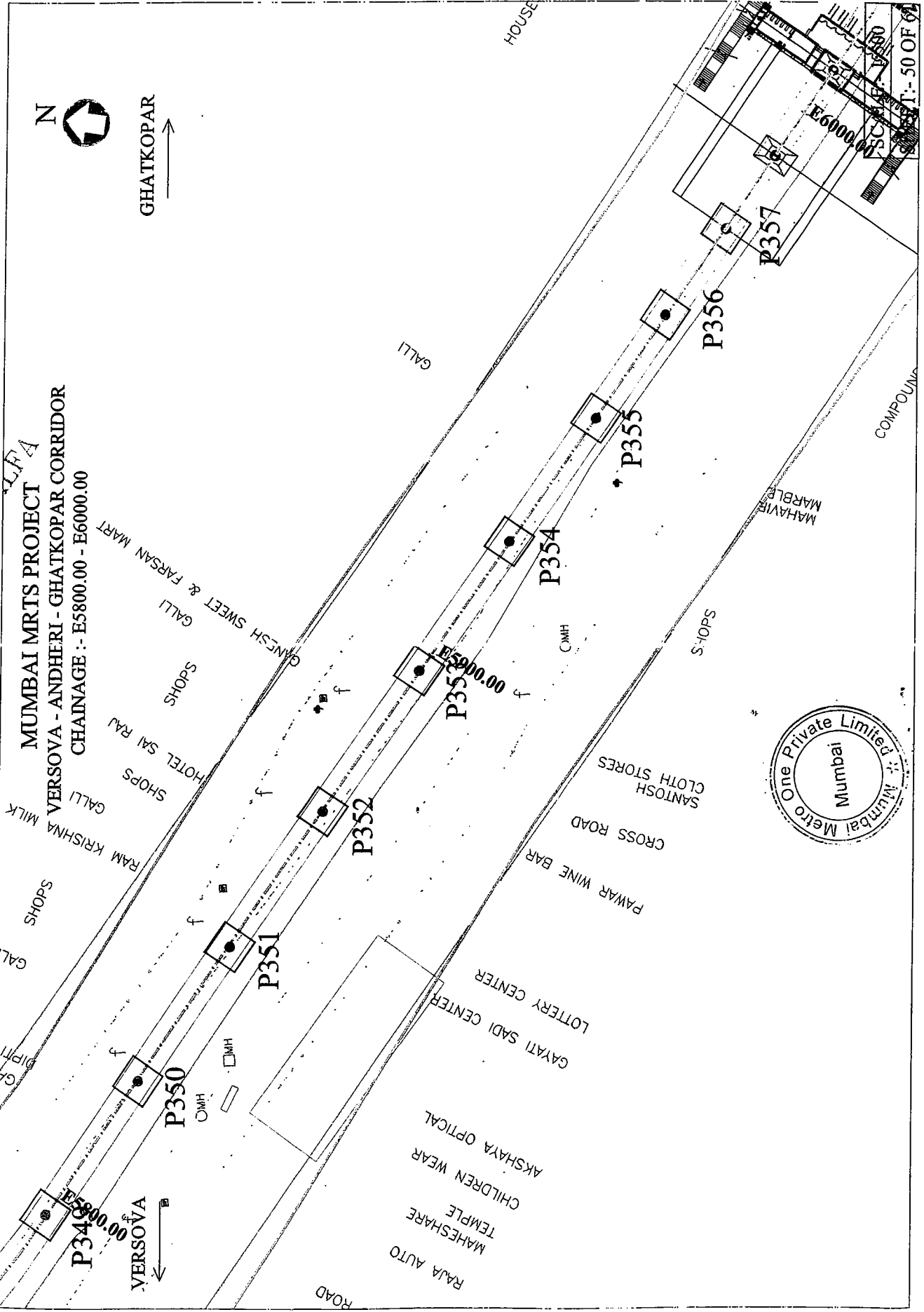

SCALE:- 1:500
SHEET:- 51 OF 50



GHATKOPAR
→

HOUSES

P361
TEMPLE

HOUSES

CHECKIN
CENTERS

P360

SHOPS

P359

P358

TO NARAYAN NAGAR NARI
SEVA SADAN ROAD

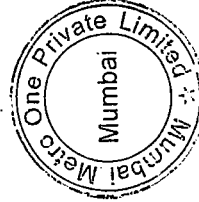

SAI NATH BAR &
RESTAURANT

←
VERSOVA

DHUMAL SERVICE STATION

MUMBAI MRTS PROJECT
VERSOVA - ANDHERI - GHATKOPAR CORRIDOR
CHAINAGE :- E6000.00 - E6200.00

SUBHASH NAGAR STATION

HOTEL
JAI BHAVANI

HOUSE

ALISHAN AUTO
APPLIANCES

GANESH

FIRE

W.C.

W.C.

W.C.

E6000

000.000

000

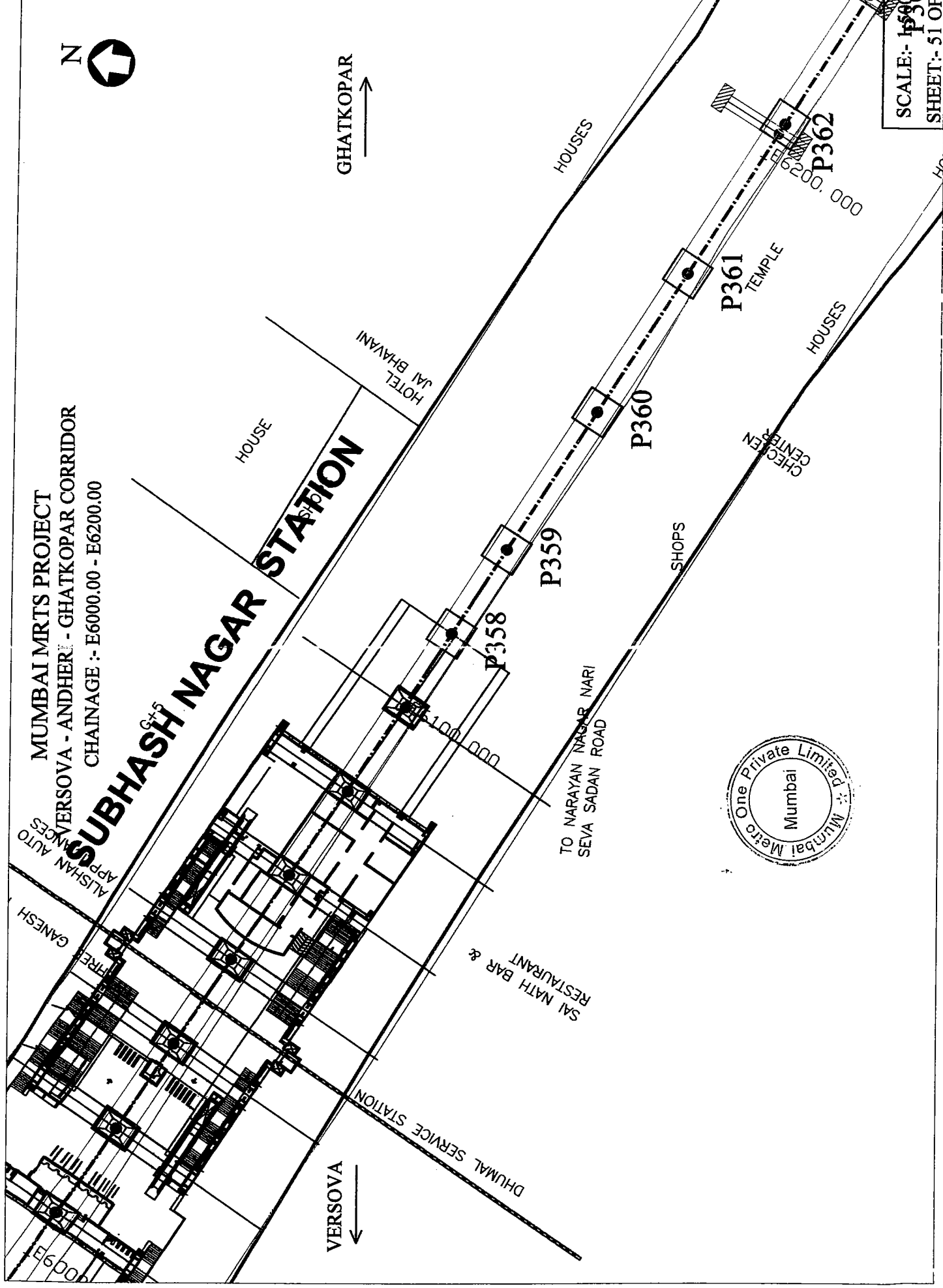

MUMBAI MRTS PROJECT
VERSOVA - ANDHERI - GHATKOPAR CORRIDOR
CHAINAGE :- E6200.00 - E6400.00



ASALPHA

GHATKOPAR

VERSOVA

JAGADANBA DEVI
TEMPLE

HOUSES

JTA AUTO

GARAGE

MEDICAL

SHOPS

SAI AUTO CONSULTANT

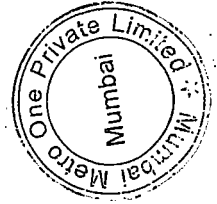

SCALE:- 1:500
SHEET:- 52 OF

WALA

HOUSE

E6200.000

E6300.000

E6400.000

P362

P363

P364

P365

P366

P367

P368

P369

P370

MUMBAI MRTS PROJECT
VERSOVA - ANDHERI - GHATKOPAR CORRIDOR
CHAINAGE :- E6400.00 - E6600.00



VERSOVA
←

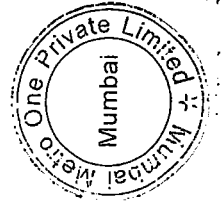
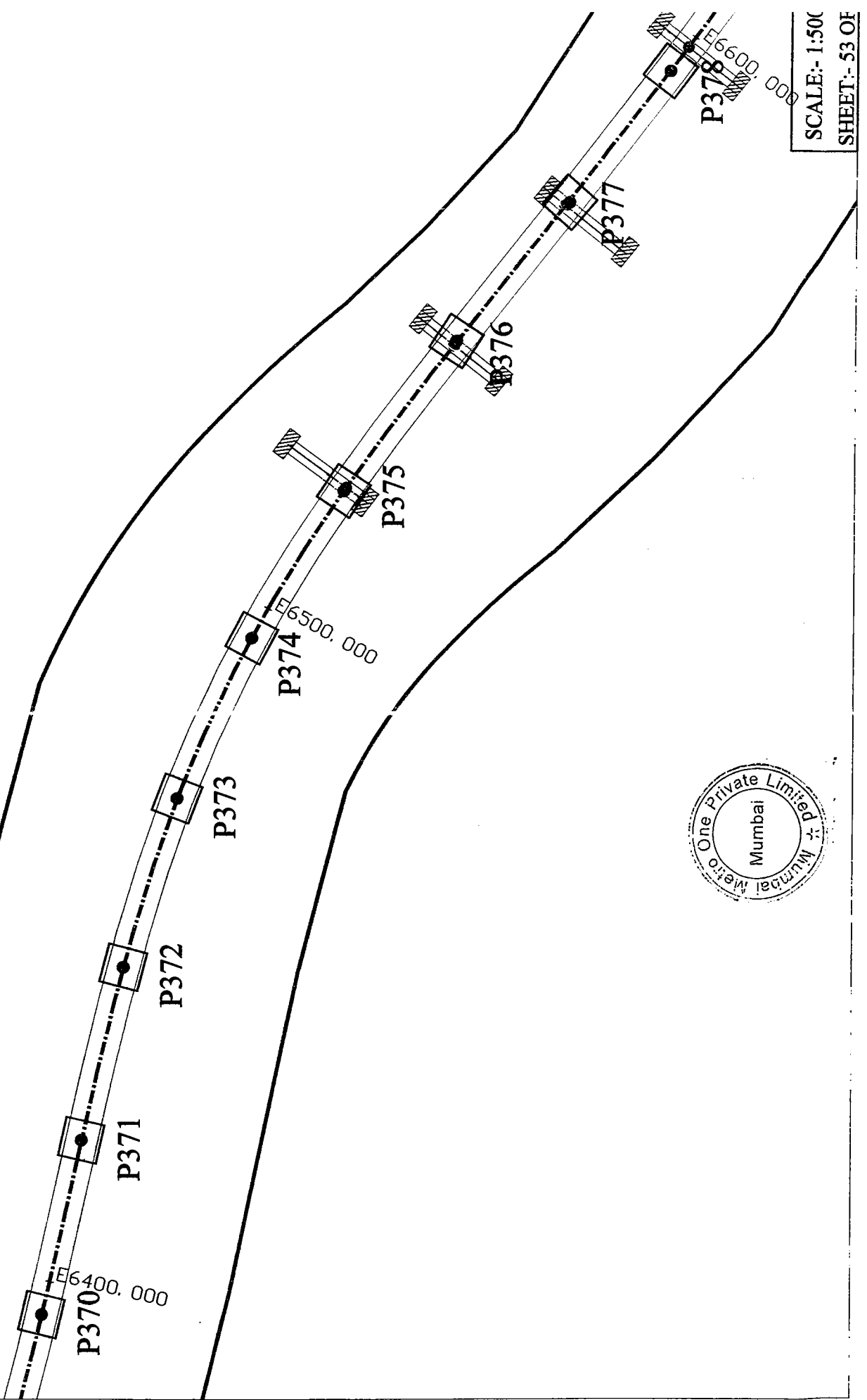

MUMBAI MRTS PROJECT
VERSOVA - ANDHERI - GHATKOPAR CORRIDOR
CHAINAGE :- E6600.00 - E6800.00



17

GHATKOPAR
→

ASALPHA ROAD STATION

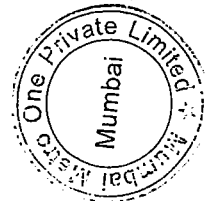
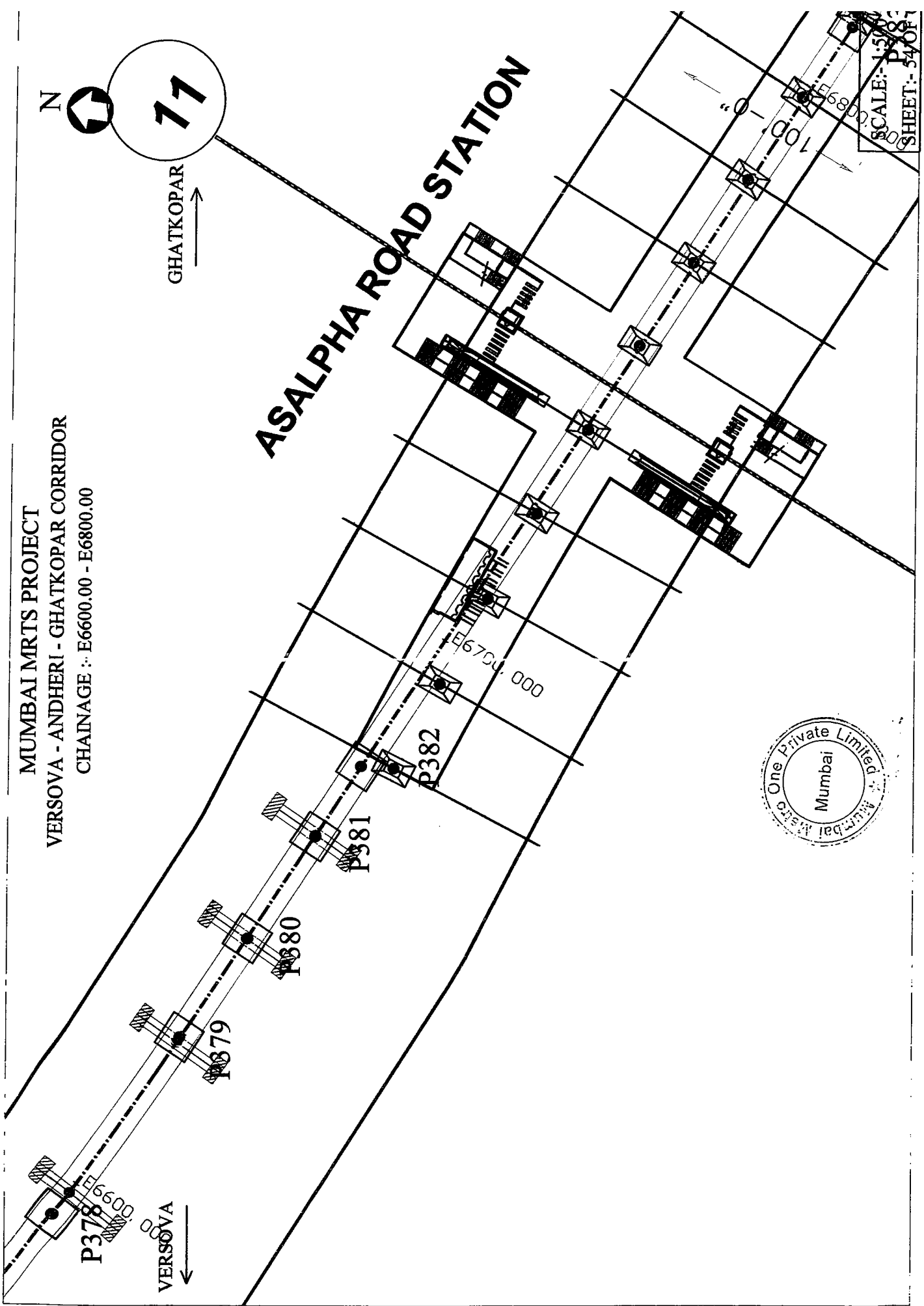

SCALE: 1:500
PROJECT: P378
SHEET: 54 OF 71

MUMBAI MRTS PROJECT
VERSOVA - ANDHERI - GHATKOPAR CORRIDOR
CHAINAGE :- E6800.00 - E7000.00



GHATKOPAR
→

VERSOVA
←

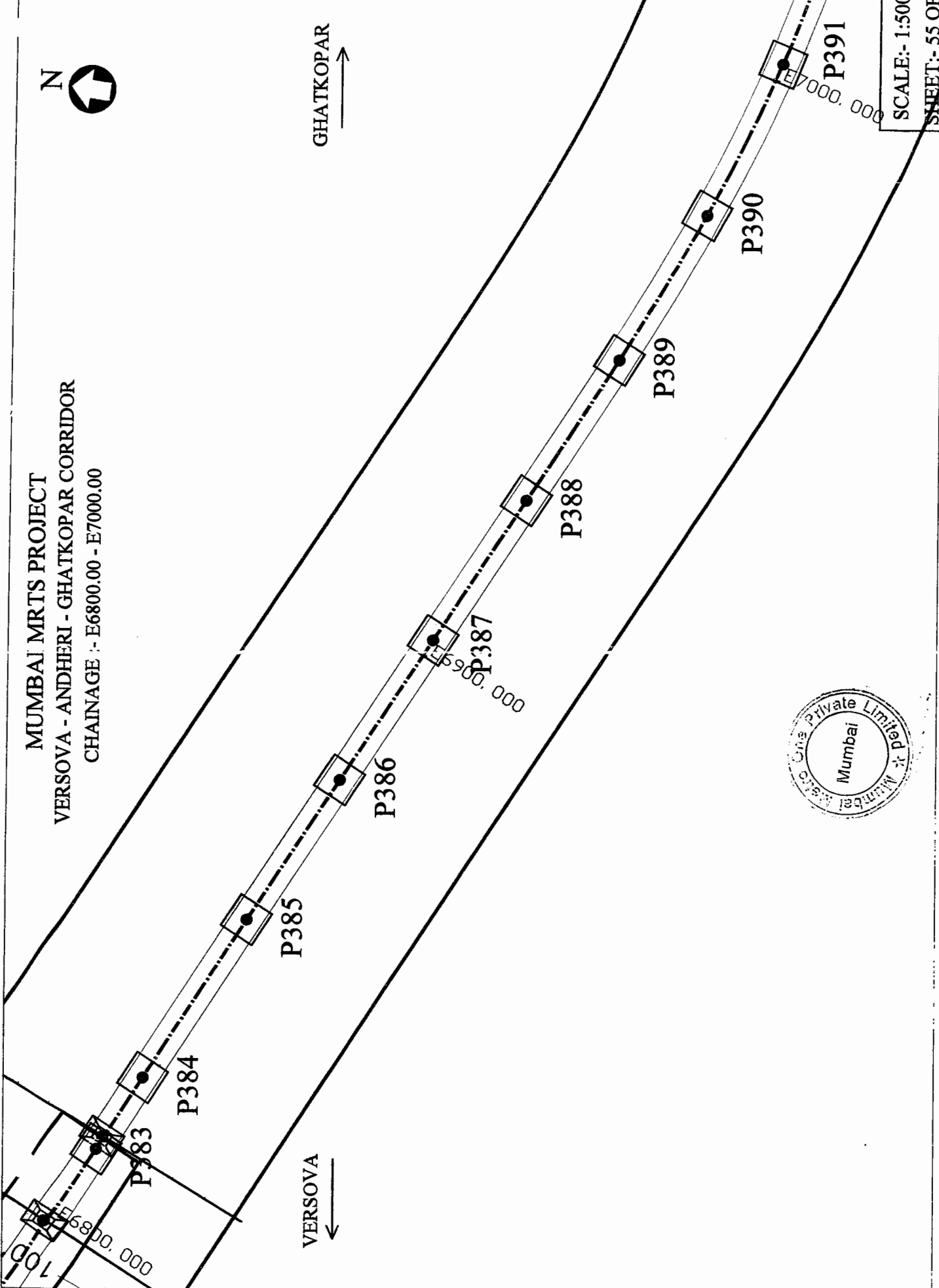

SCALE:- 1:500
SHEET:- 55 OF

MUMBAI MRTS PROJECT
VERSOVA - ANDHERI - GHATKOPAR CORRIDOR
CHAINAGE :- E7000.00 - E7200.00



VERSOVA
←

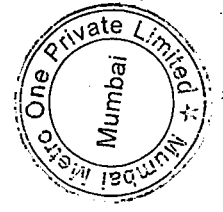
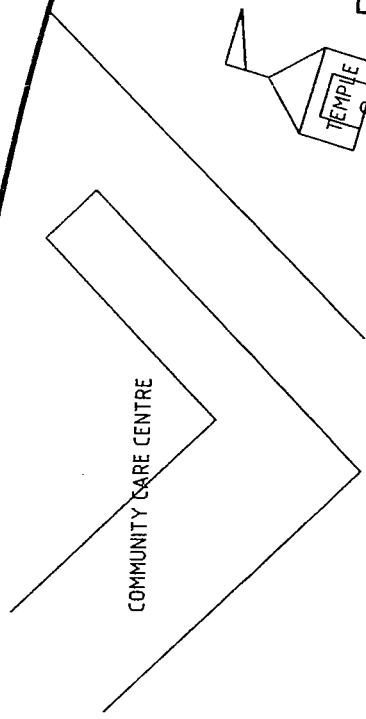
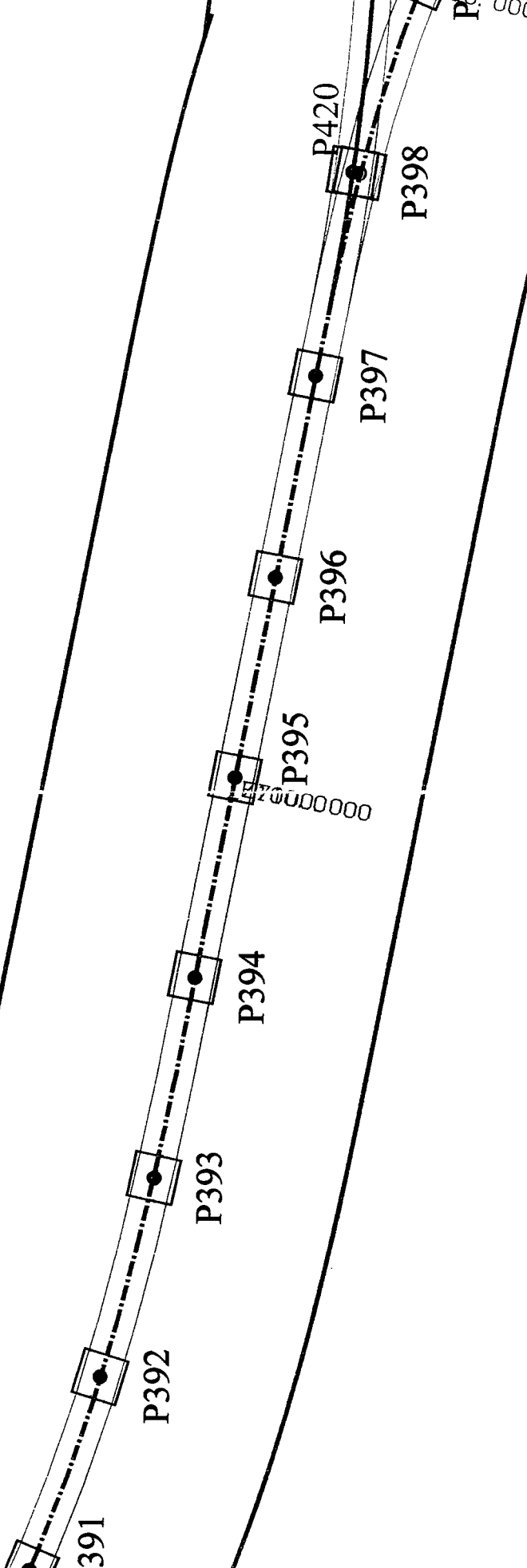

SCALE:- 1:500
SHEET:- 56 OF

1. JMBAI MRTS PROJECT
VERSOVA - ANDHERI - GHATKOPAR CORRIDOR
CHAINAGE :- E7:200.00 - E7300.00



GHATKOPAR
→

VERSOVA
←

SLUM

RESIDENTIAL BUILDING
G+3

MAHAVIR BUILDING
G+3



DEV DARSHAN

SCALE:- 1:50
SHEET:- 57 OF

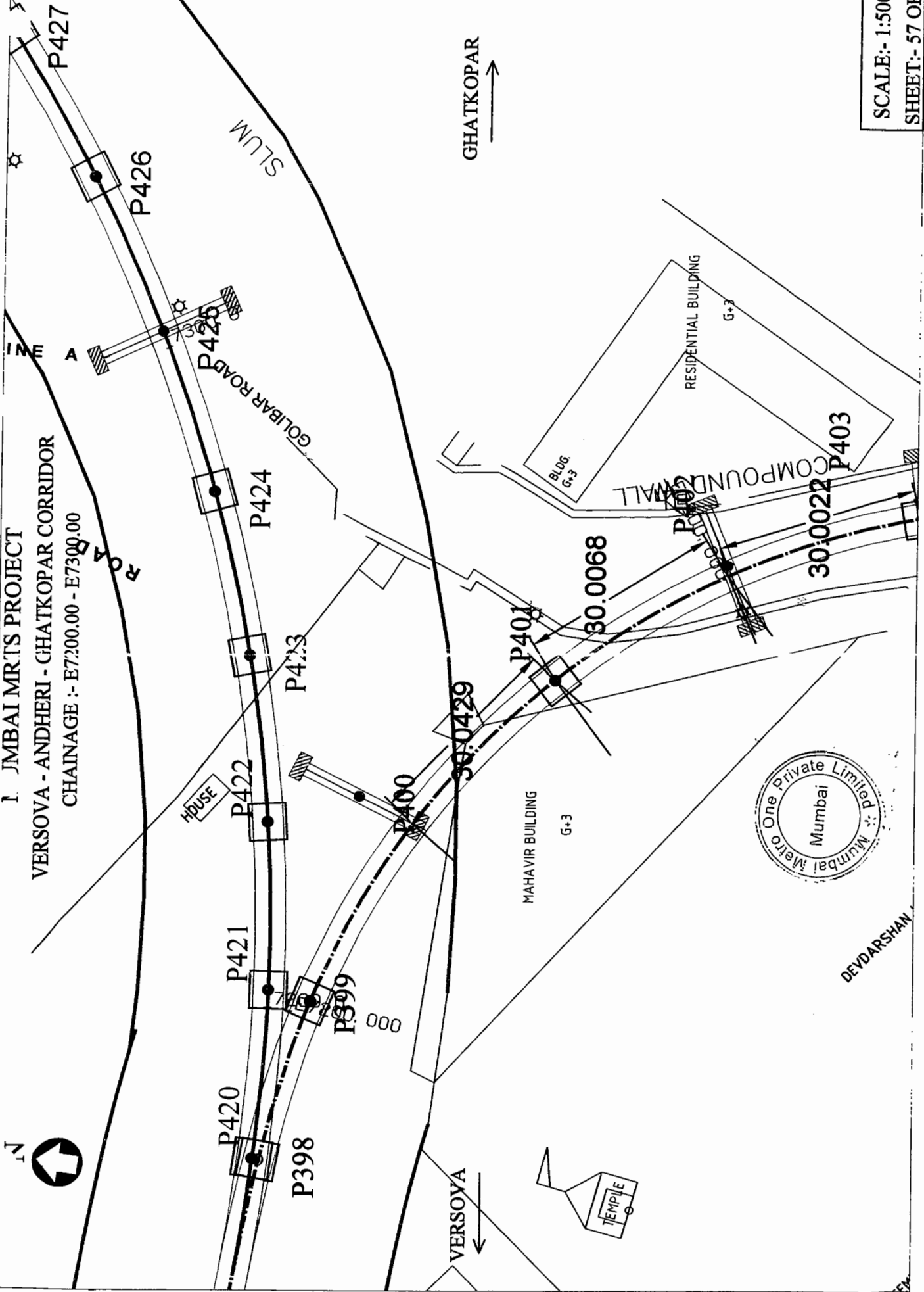

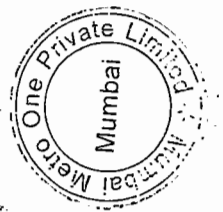

GHATKOPAR
→

MUMBAI METRO PROJECT
VERSOVA - ANDHERI - GHATKOPAR CORRIDOR
CHAINAGE :- E7300.00 - E7400.00

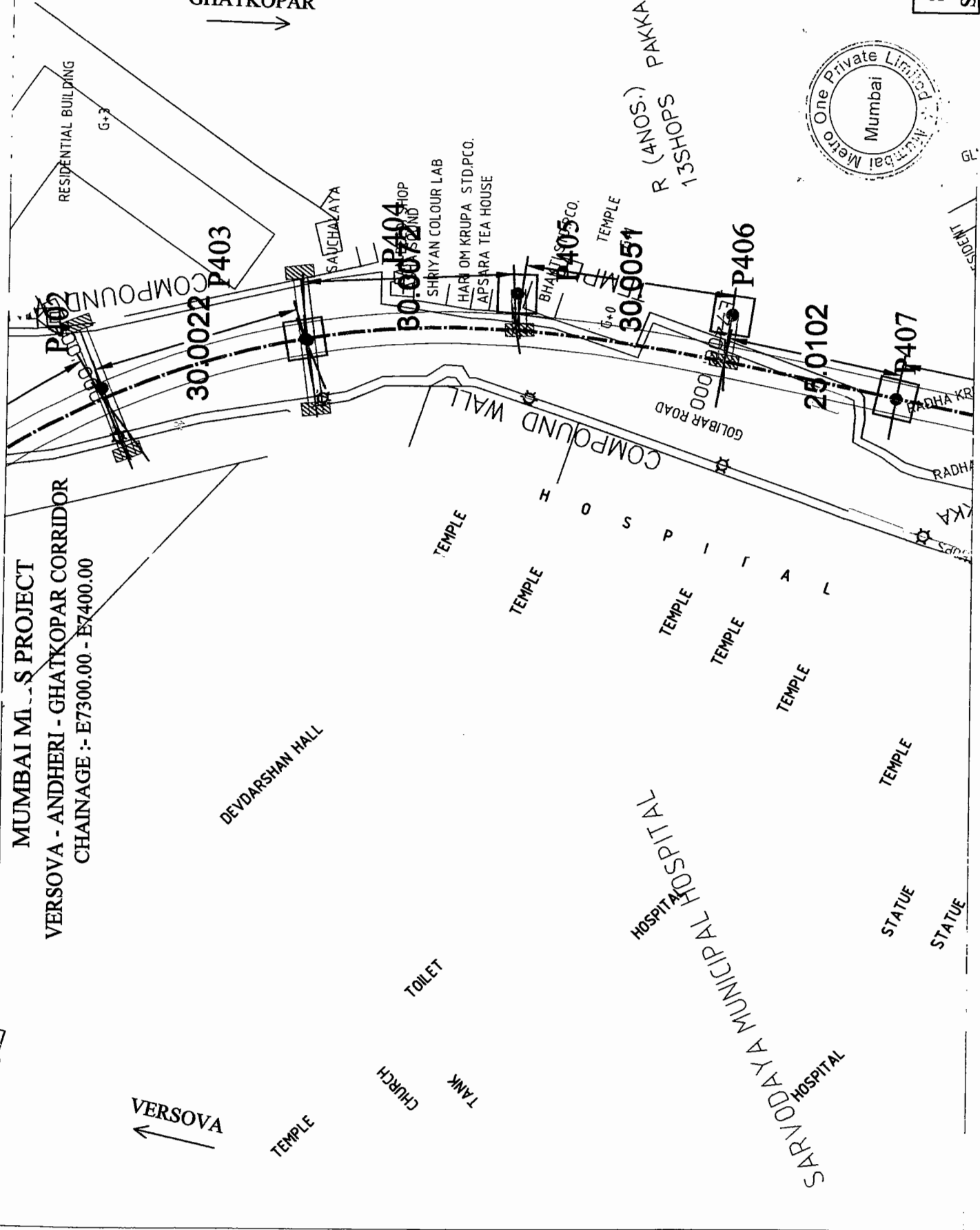

←
VERSOVA

13 SHOPS
R (ANOS.) PAKKKA

SARVODAYA MUNICIPAL HOSPITAL
HOSPITAL

STATUE
STATUE

TEMPLE

TEMPLE

TEMPLE

TEMPLE

TEMPLE

KAKA

RADHA KRISHNA

GOLIBAR ROAD

COMPUND WALL

RESIDENTIAL BUILDING
G+3

SAUCHAKAYA

SHOP
30:0072

SHRIYAN COLOUR LAB

HARI OM KRUPA STD.PCO.

APSARA TEA HOUSE

BHARTIYA CO.
P405

TEMPLE

30:0051

P406

25:0102

P407

13 SHOPS

MUMBAI MRTS PROJECT
VERSOVA - ANDHERI - GHATKOPAR CORRIDOR
CHAINAGE :- E7400.00 - E7500.00

SARVODAYA
HOSPITAL

↑
VERSOVA

TEMPLE
TEMPLE
TEMPLE

STATUE

STATUE

SHOP

TEMPLE

R (ANOS.) BM FROM BW
TEMPLE

COMPOUND WALL

GOLBAR ROAD

25.0102

P407

25.0123

P408

24.742

IP409

20.8455

P410

P406

→
GHATKOPAR

GLOBLE VISION

SHOPS-RESIDENT

HOT SHOP

RADHA KRISHNA RESTAURANT

SHOPS
RABAS CLEANING SHOP

MILAN MEDICAL STORES

PAKKA

TO PARKSIDE

L. B. S. MARG

LAL BAHADUR SAH
ROAD

6CHJ

SARVODAYA HOSPITAL
JUNCTION

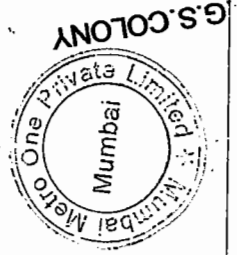

SCALE:- 1:500
SHEET:- 59 OF



MUMBAI MRTS PROJECT
VERSOVA - ANDHERI - GHATKOPAR CORRIDOR
CHAINAGE :- E7500.00 - E7600.00

JUNCTION



C.G.S.COLONY

GHATKOPAR

MUNICIPAL RETAIL MARKET

VERSOVA

CONCRETE ROAD

150 MM Ø

P410

P411

P412

P413

P414

(G+2)

(G+2)

(G+2)

G+3

G+3

56.185

56.185

56.185

56.185

56.185

56.185

56.185

56.185

56.185

56.185

56.185

56.185

56.185

56.185

56.185

56.185

56.185

56.185

56.185

56.185

56.185

D.P.

S.B.

D.P.

D.P.

D.P.

D.P.

D.P.

D.P.

D.P.

OPEN GROUND

S.DRAIN



SCALE:- 1:500
SHEET:- 60 OF

DATE: 10/01/2011

MUMBAI MRT'S PROJECT
VERSOVA - ANDHERI - GHATKOPAR CORRIDOR
CHAINAGE :- E7600.00 - E7700.00

REVERSE CURVE

VERSOVA

GHATKOPAR

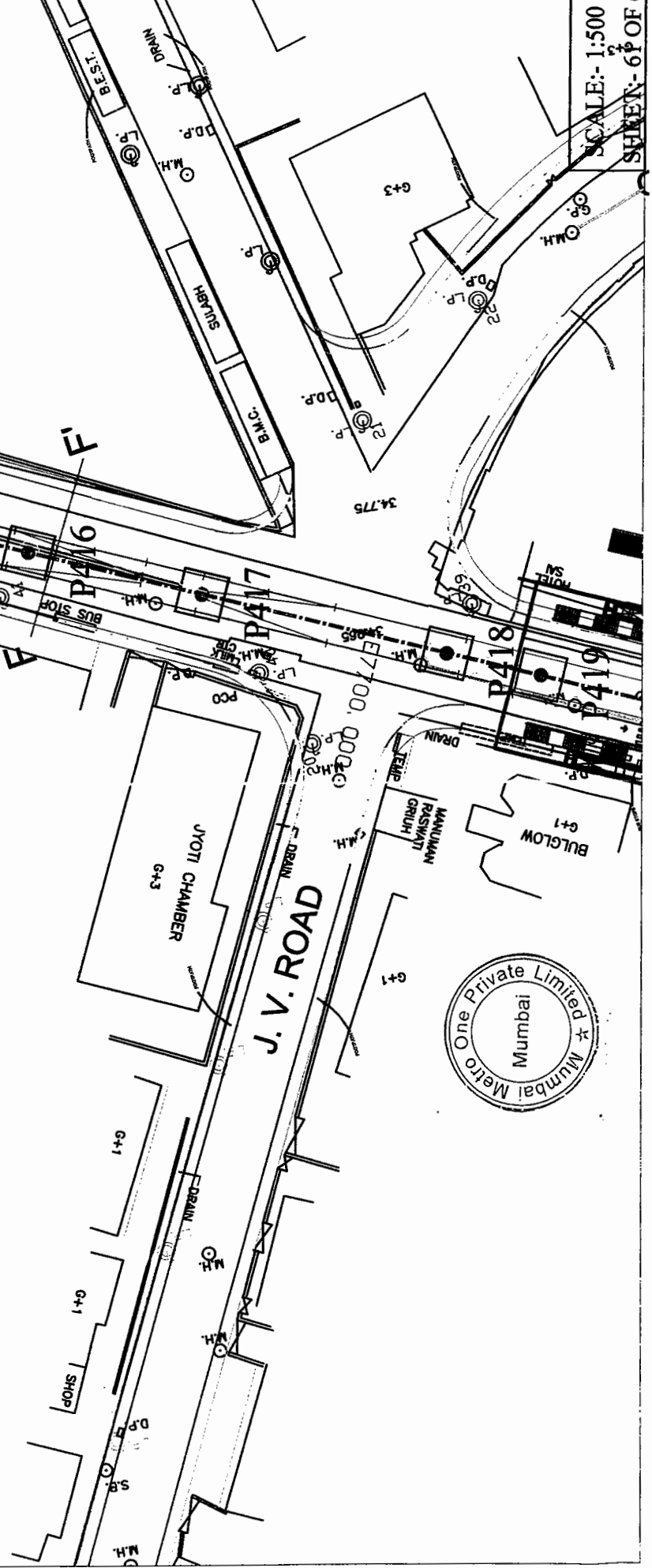

SCALE:- 1:500
SHEET- 6 OF 6

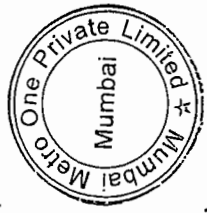

MUMBAI MRTS PROJECT
VERSOVA - ANDHERI - GHATKOPAR CORRIDOR
CHAINAGE :- E7600.00 - E7700.00

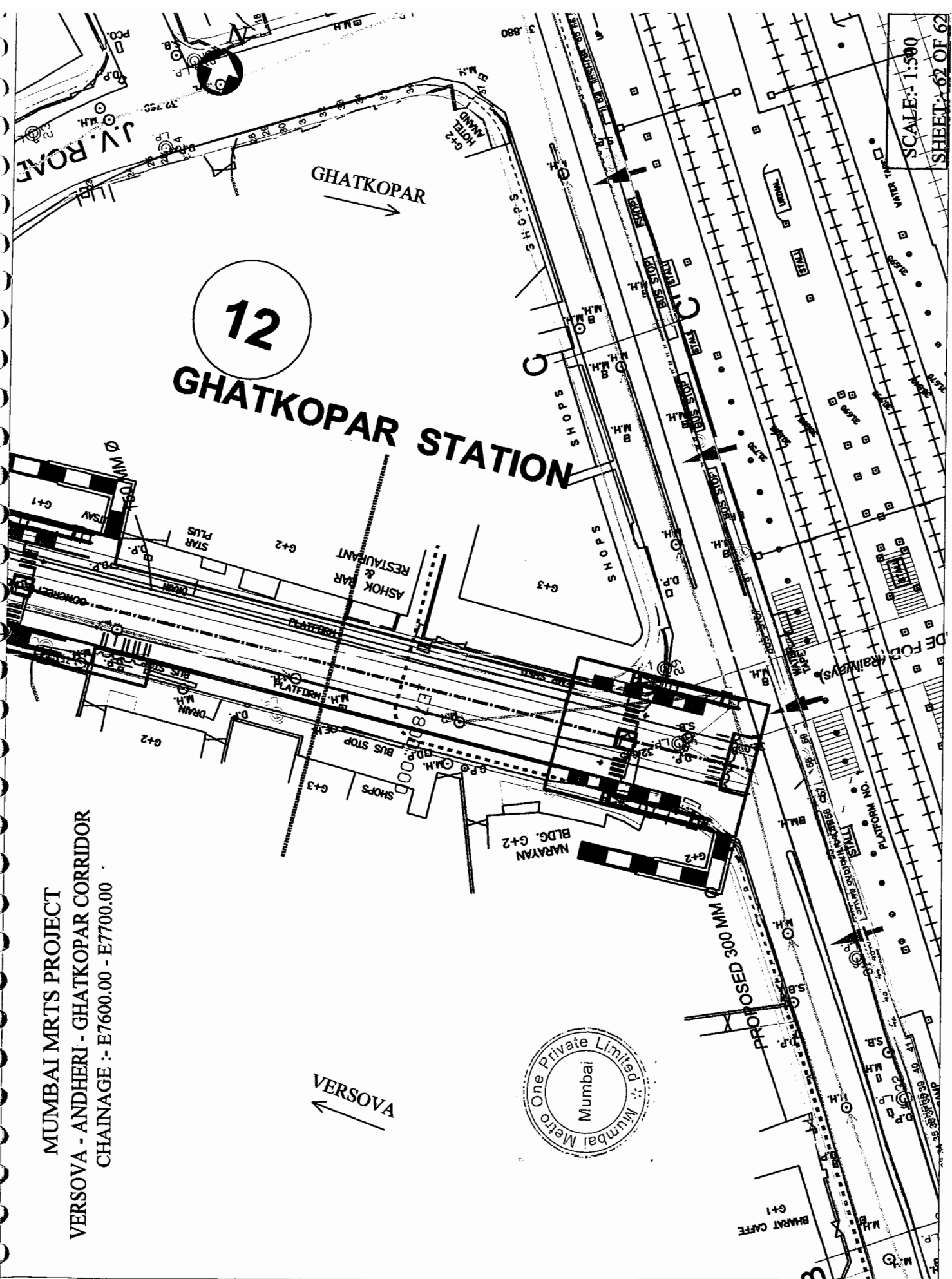

PART B

TYPICAL STATION DRAWINGS

	Title Station Location	Drawing/ Figure No.
1	Versova Station	Figure 1
2	D.N.Nagar Station	Figure 2
3	Azad Nagar Station	Figure 3
4	Andheri Station	Figure 4b
5	WEH Station	Figure 5
6	Chakala Station	Figure 6
7	Airport Road Station	Figure 7
8	Marol Naka Station	Figure 8
9	Saki Naka Station	Figure 9
10	Subash Nagar Station	Figure 10
11	Asalpha Road Station	Figure 11
12	Ghatkopar Station	Figure 12



ROAD LEVEL PLAN

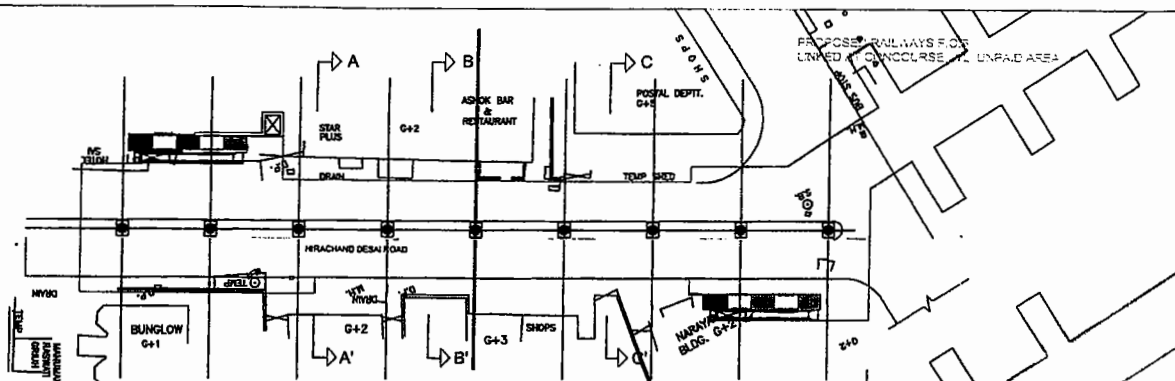

CONCOURSE LEVEL PLAN

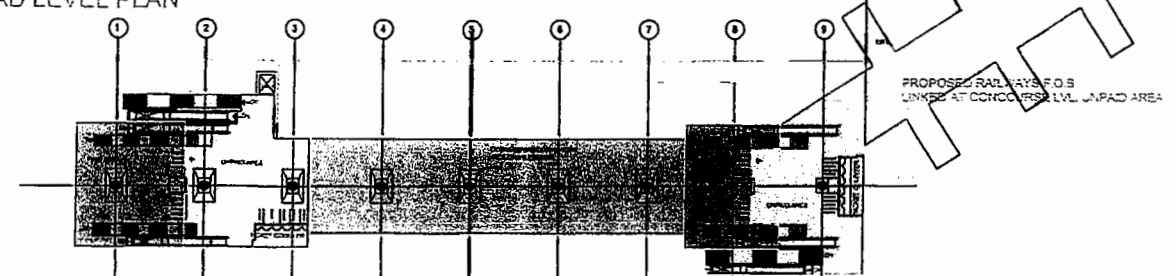

PLATFORM LEVEL PLAN

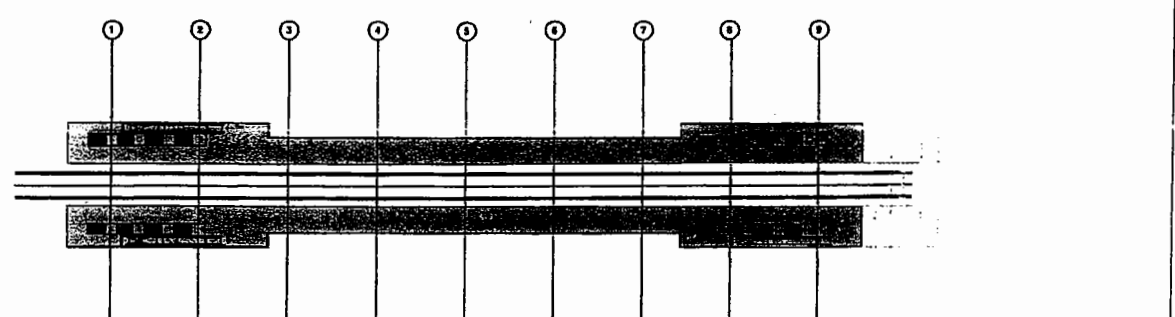
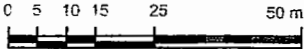

SECTION AT AA'

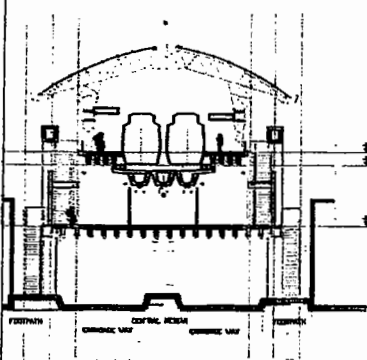

SECTION AT BB'

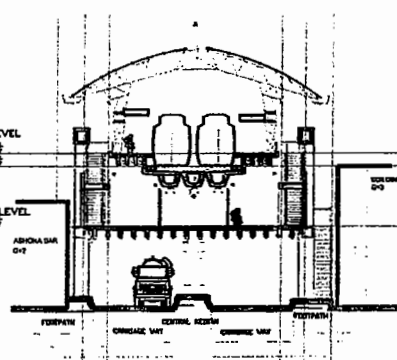

SECTION AT CC'

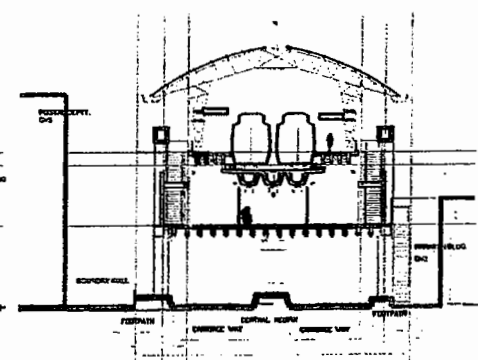

CROSS SECTIONS

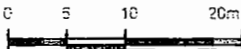

GHATKOPAR STATION
 Versova - Andheri - Ghatkopar
 East West MRTS Corridor
 Figure 12



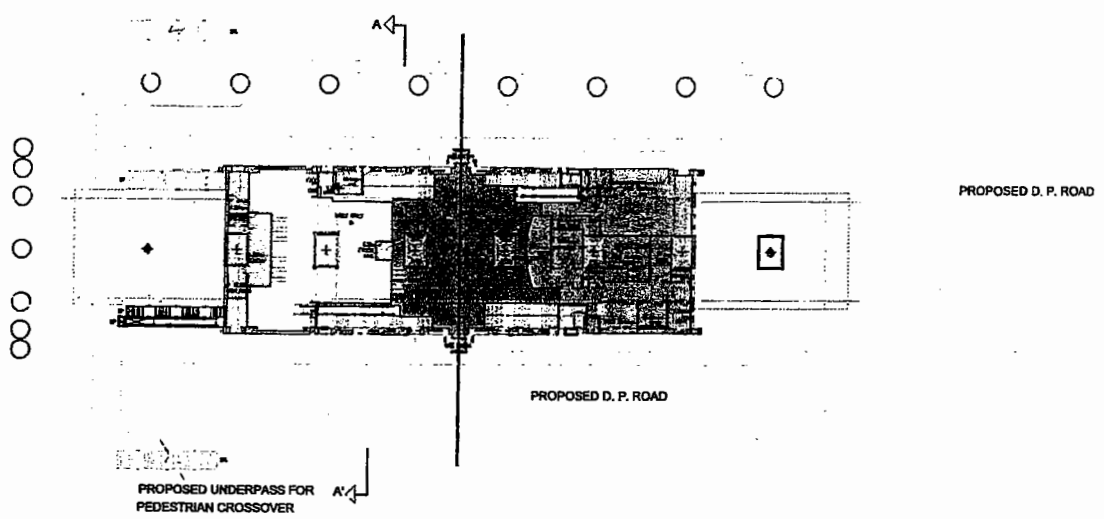

ROAD LEVEL PLAN

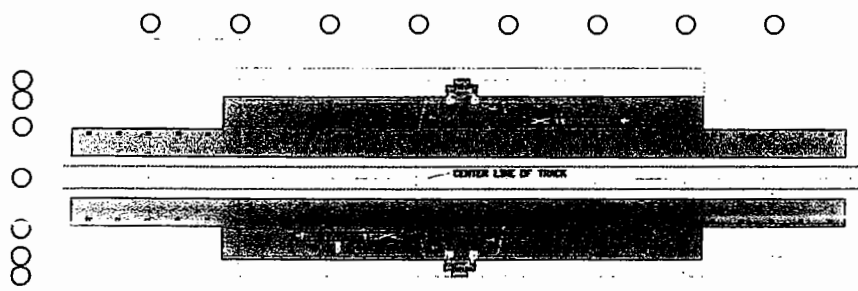

PLATFORM LEVEL PLAN

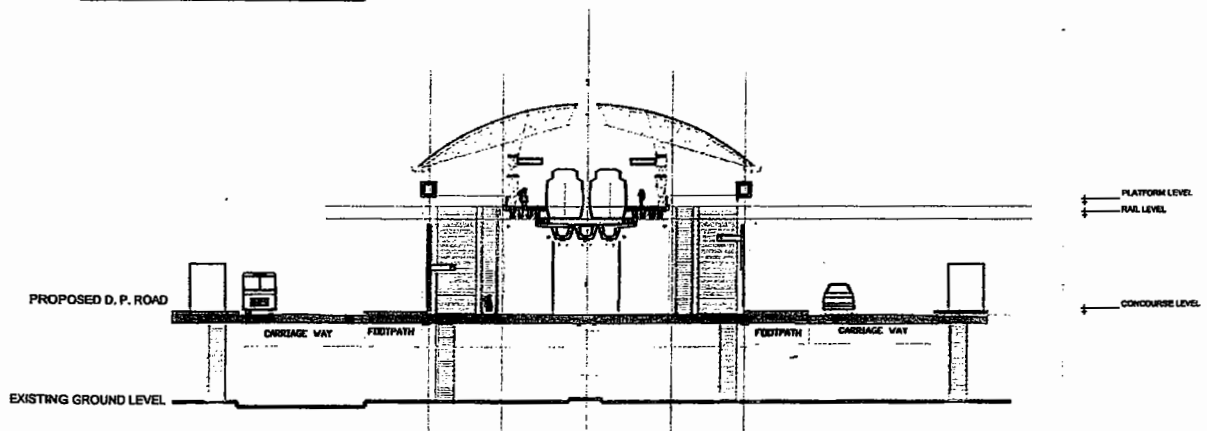
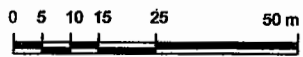

CROSS SECTION AT AA'

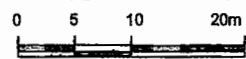

ASALPHA ROAD STATION
 Versova - Andheri - Ghatkopar Corridor
 East West MRTS Corridor
 Figure 11

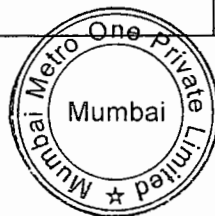

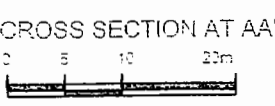
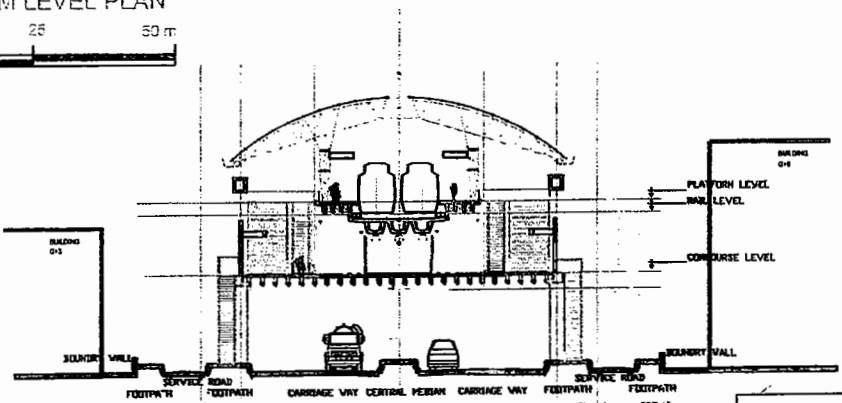
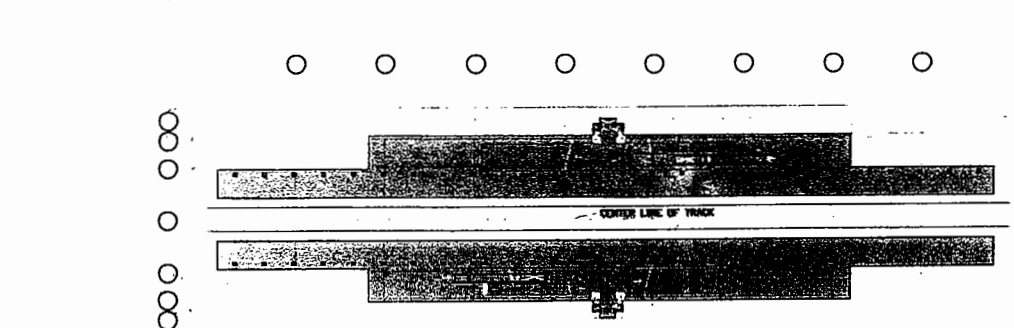
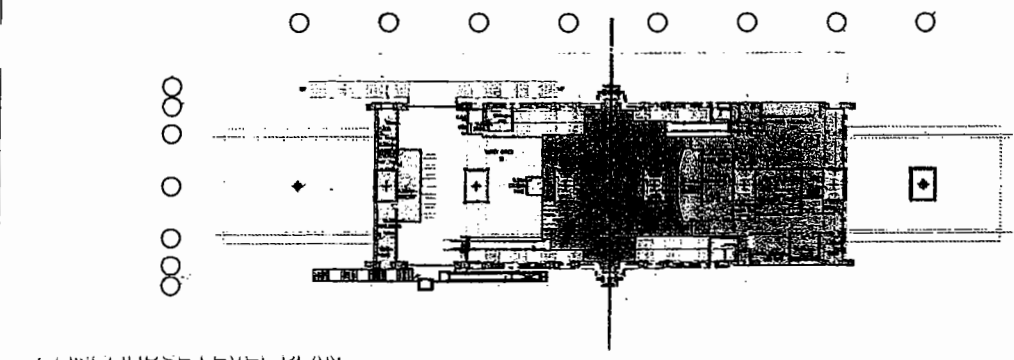
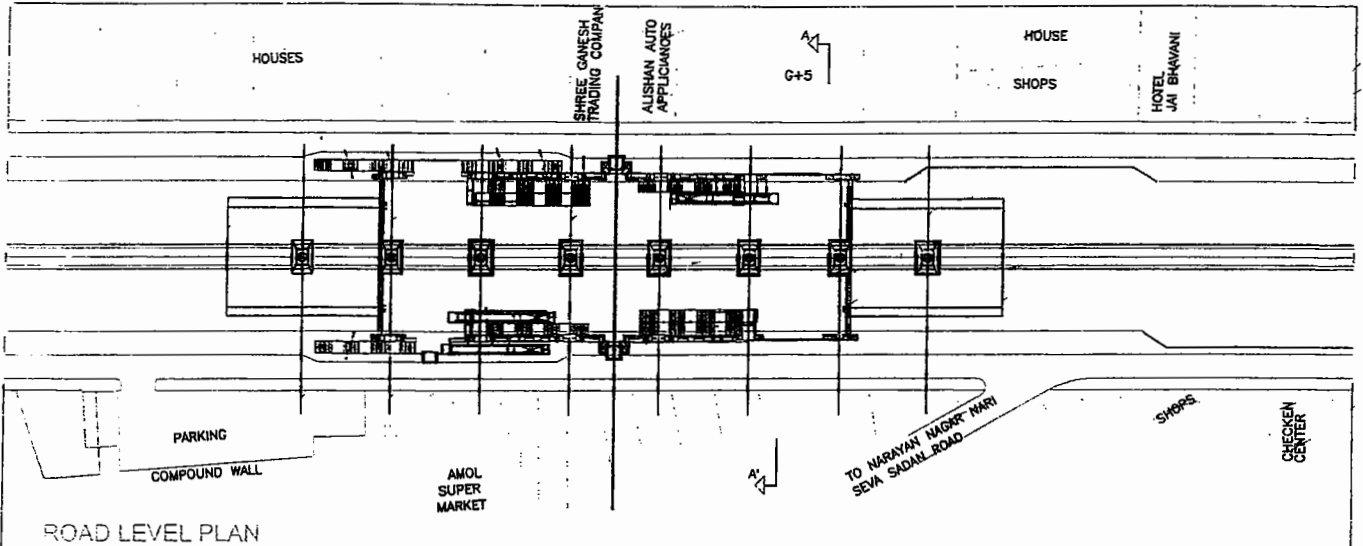

SUBHASH NAGAR STATION
 Versova - Andheri - Ghatkopar Corridor
 East West MRTS Corridor
 Figure 10



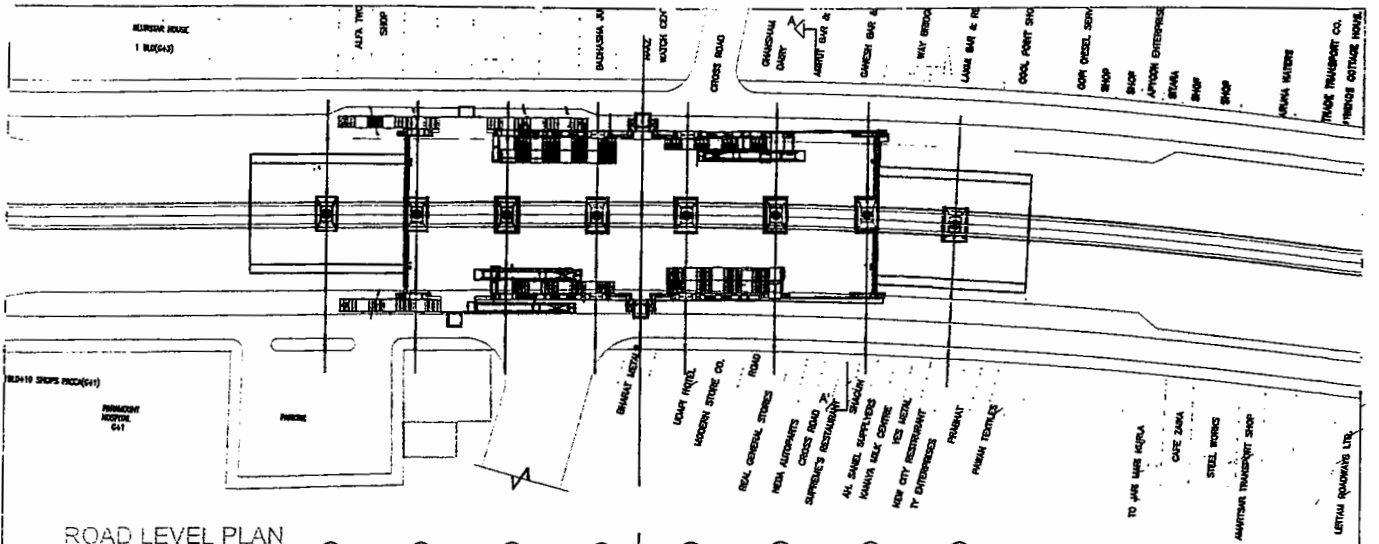

ROAD LEVEL PLAN

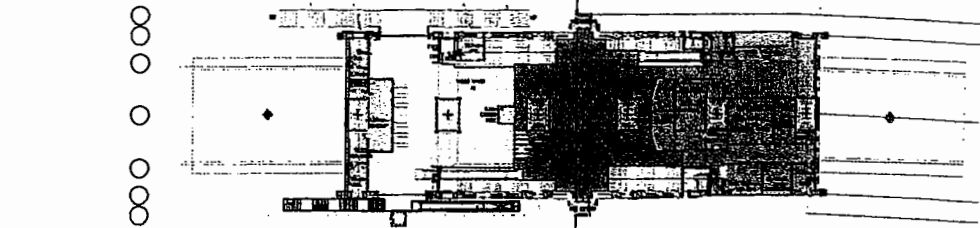

CONCOURSE LEVEL PLAN

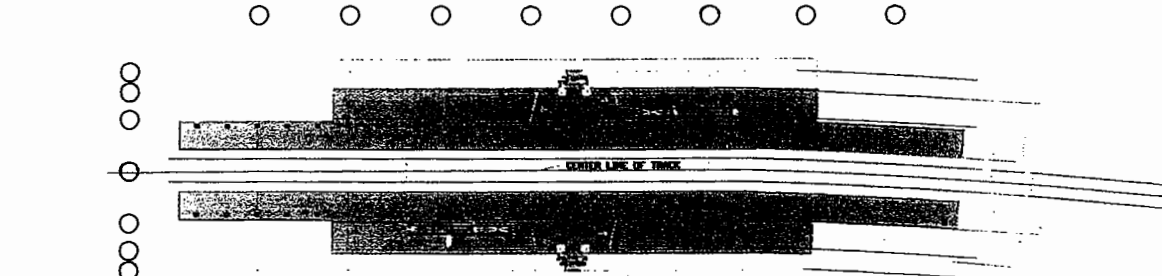

PLATFORM LEVEL PLAN

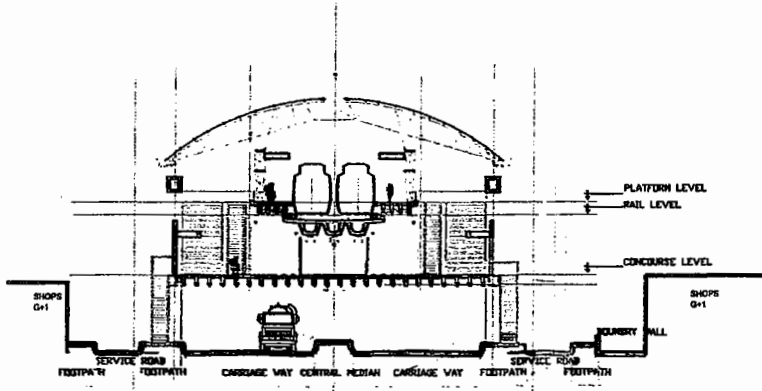
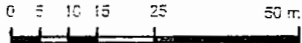

CROSS SECTION AT AA'

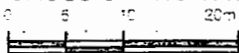

SAKI NAKA STATION
 Versover - Andheri - Ghātākopar Corridor
 East West MRTS Corridor
 Figure 9



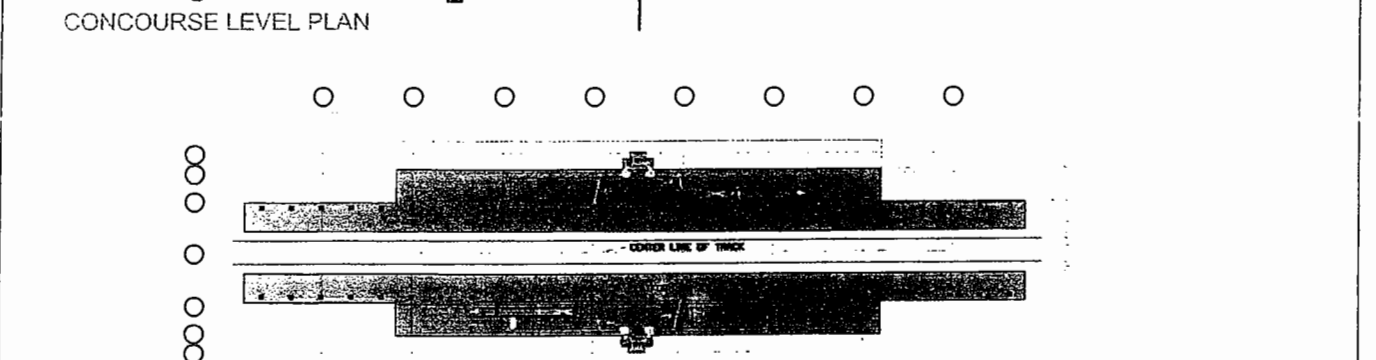
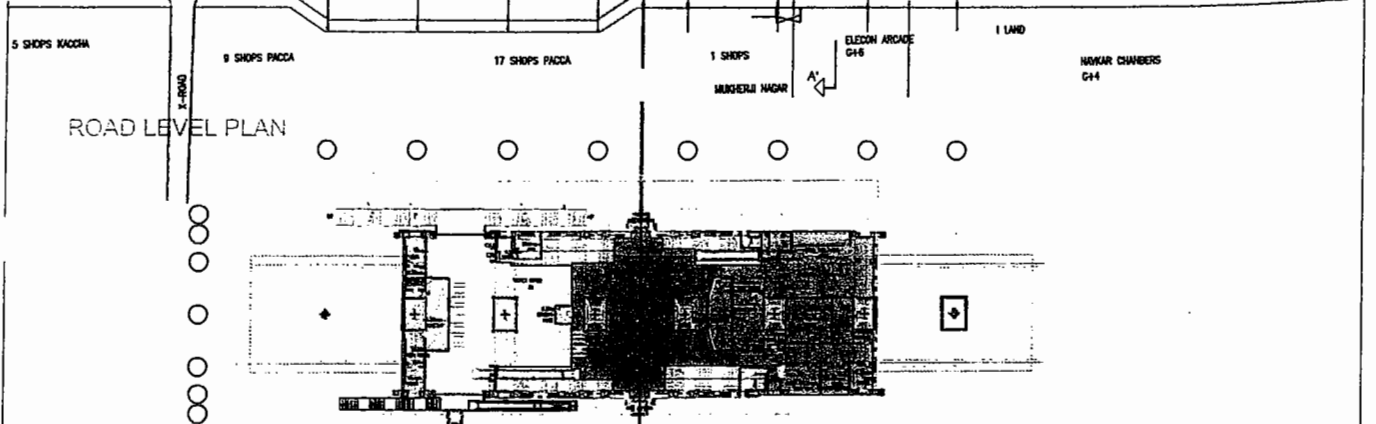
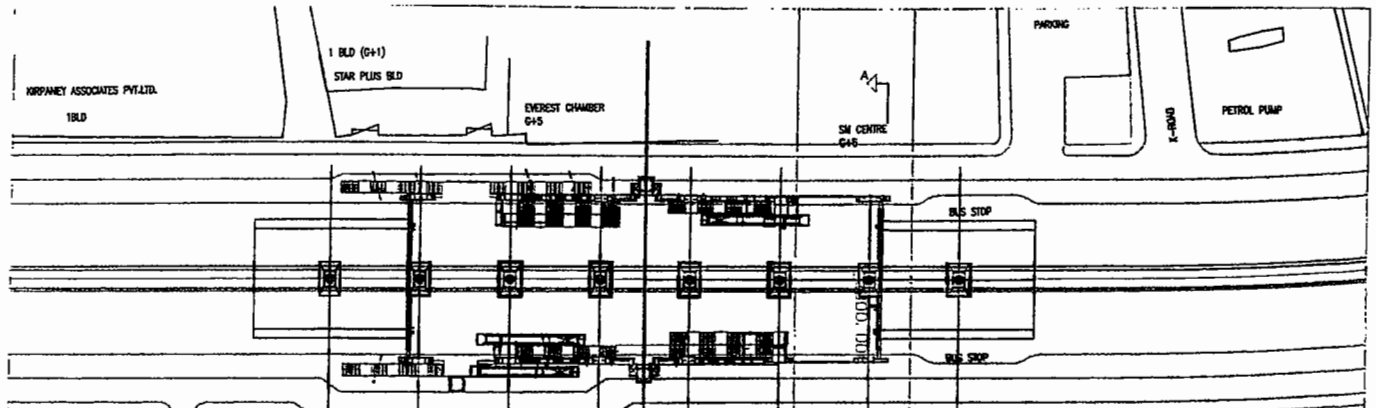

0 5 10 15 25 50 m

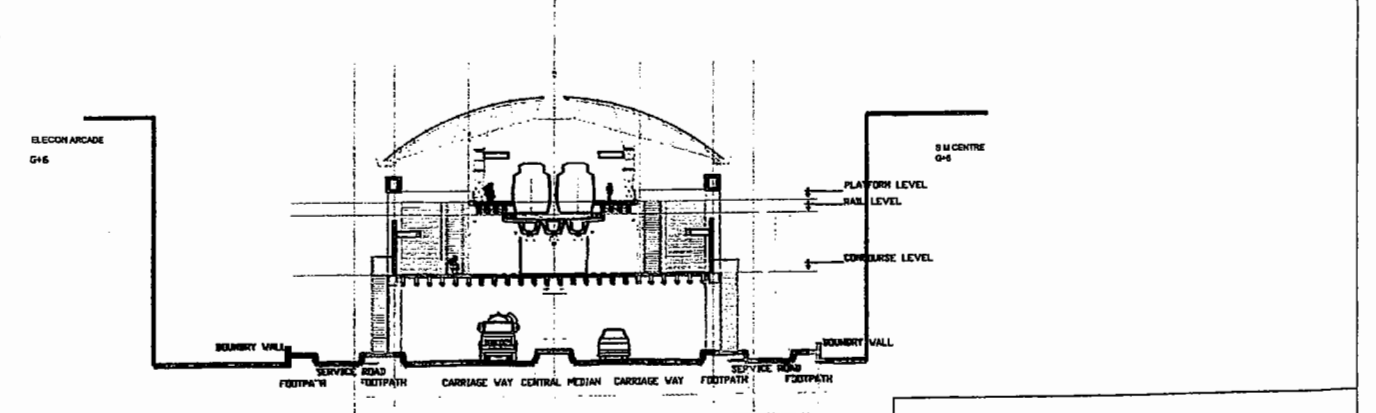

0 5 10 20 m

MAROL NAKA STATION
 Versova - Andheri - Ghatkopar
 East West MRTS Corridor
 Figure 8



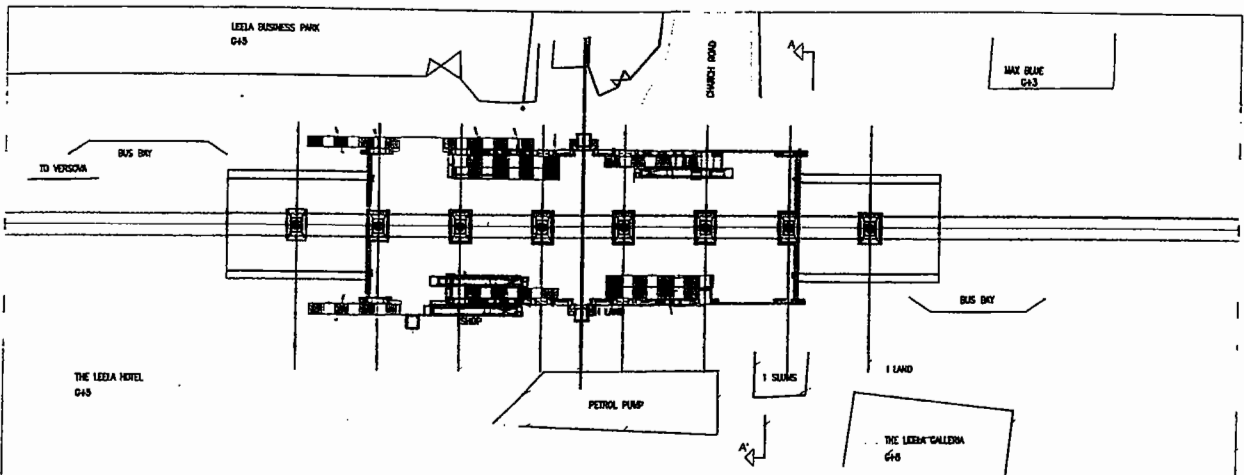

ROAD LEVEL PLAN

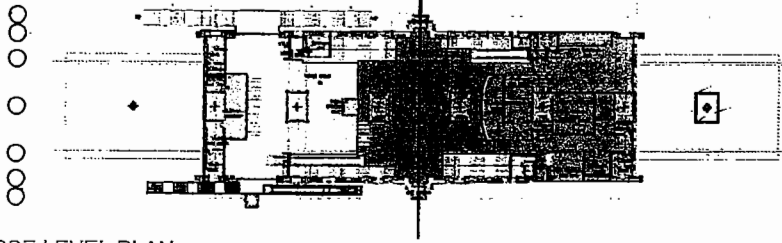

CONCOURSE LEVEL PLAN

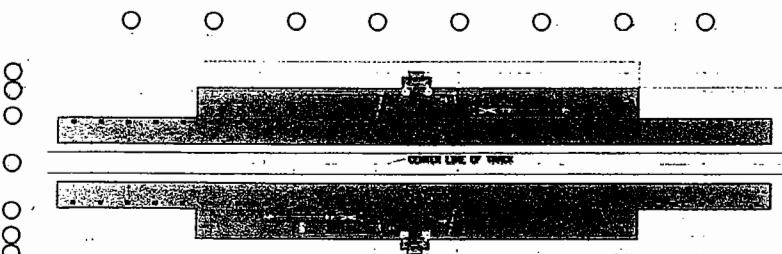

PLATFORM LEVEL PLAN

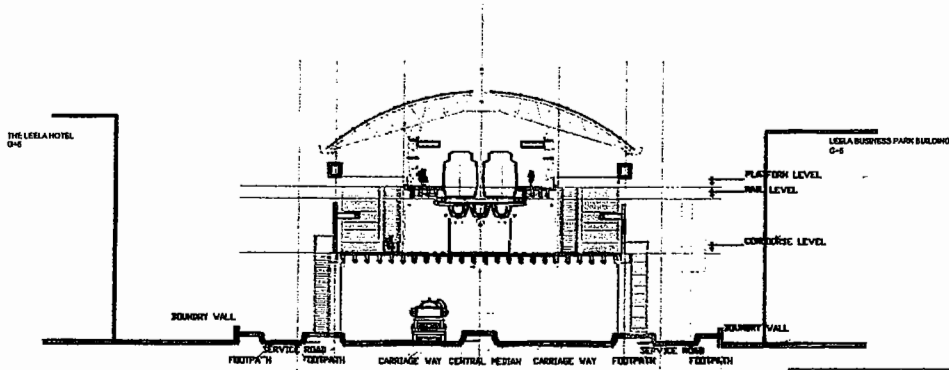
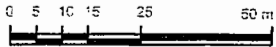

CROSS SECTION AT AA'



AIRPORT ROAD STATION
Versova - Andheri - Ghatkoper Corridor
East West MRTS Corridor
Figure 7



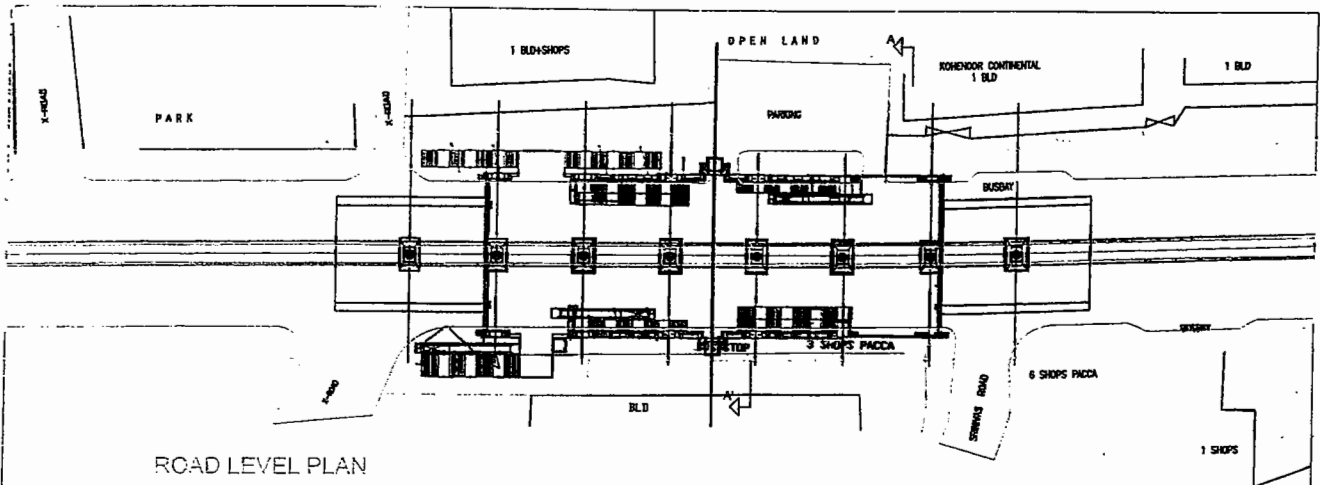

ROAD LEVEL PLAN

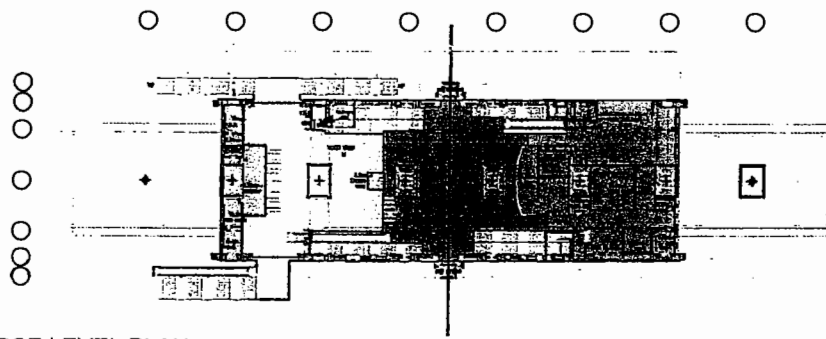

CONCOURSE LEVEL PLAN

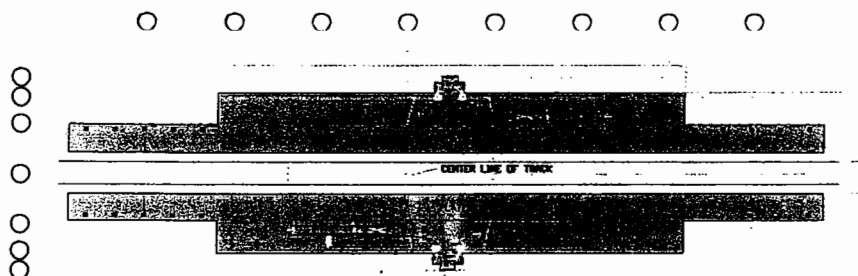

PLATFORM LEVEL PLAN

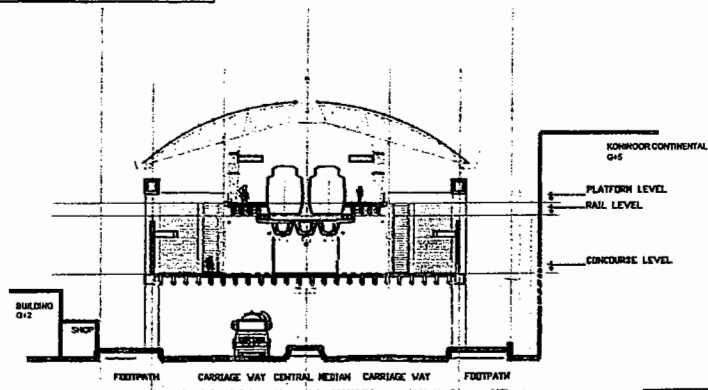

CROSS SECTION AT AA'

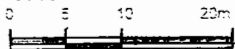

CHAKALA STATION
Versova - Andheri - Ghatkopar Corridor
East West MRTS Corridor
Figure 6



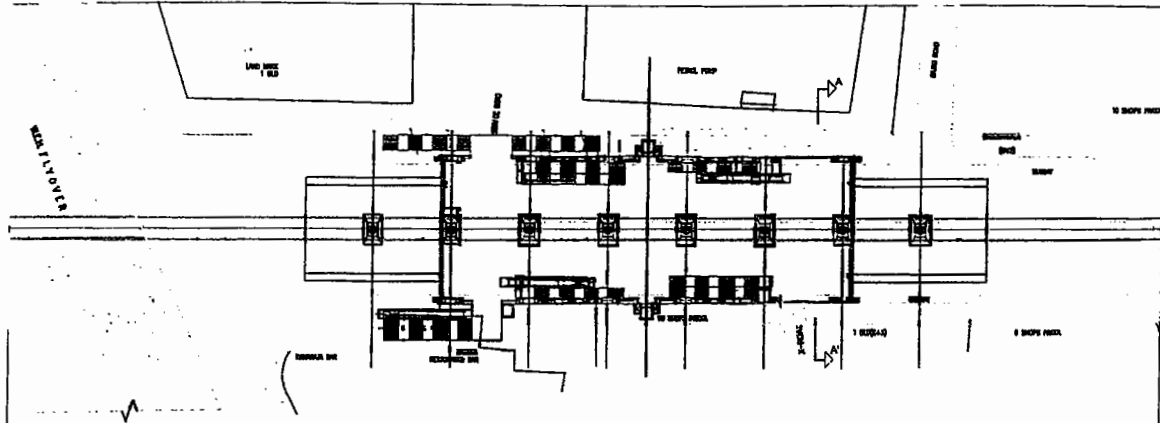

ROAD LEVEL PLAN

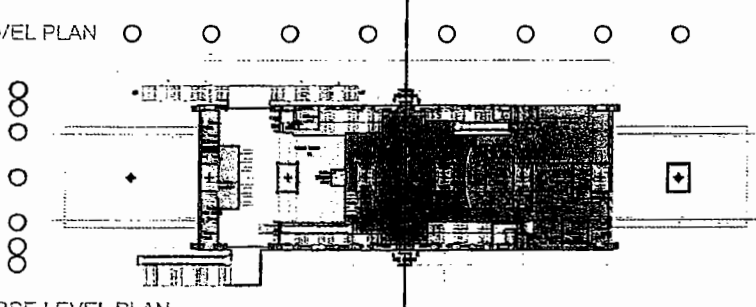

CONCOURSE LEVEL PLAN

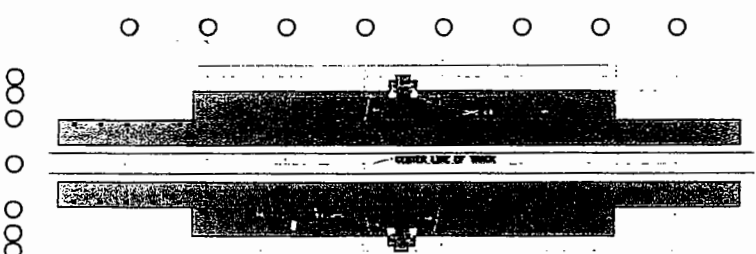

PLATFORM LEVEL PLAN

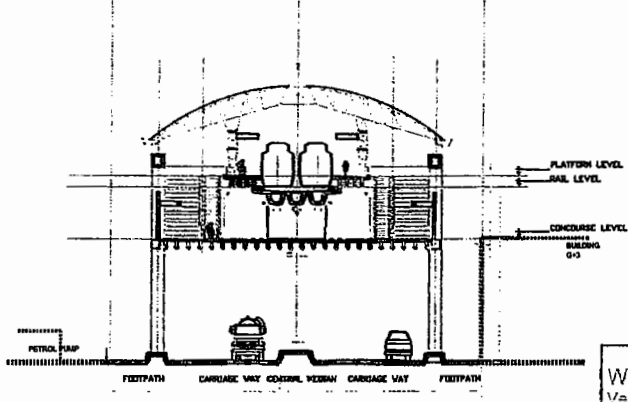
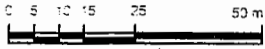

CROSS SECTION AT AA



WEH STATION
 Versova - Anchari - Ghatkopar
 East West MRTS Corridor
 Figure 5



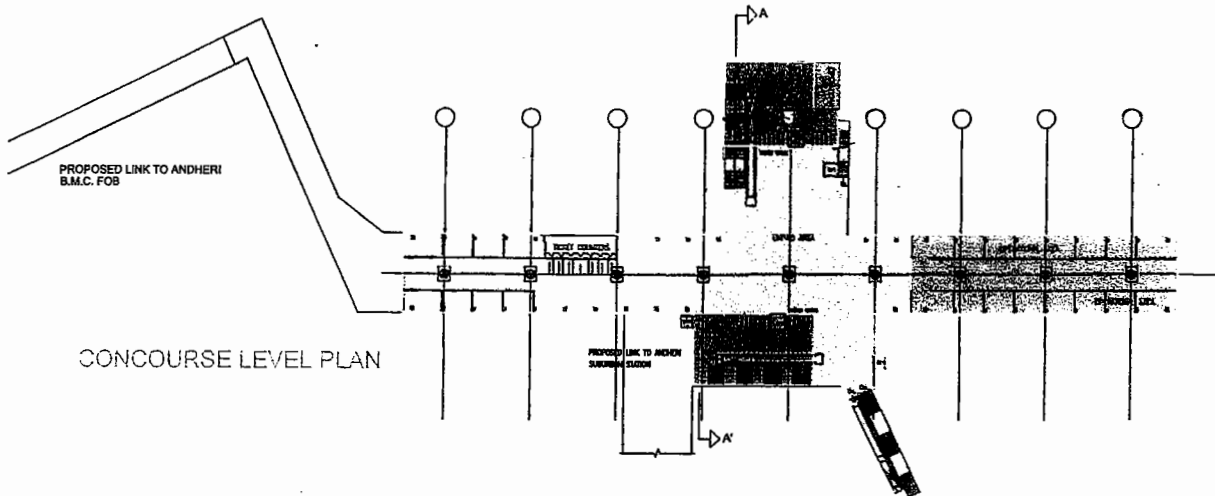

CONCOURSE LEVEL PLAN

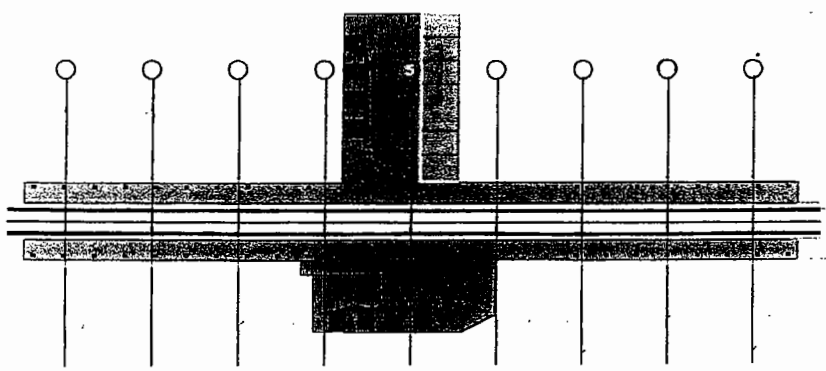

PLATFORM LEVEL PLAN

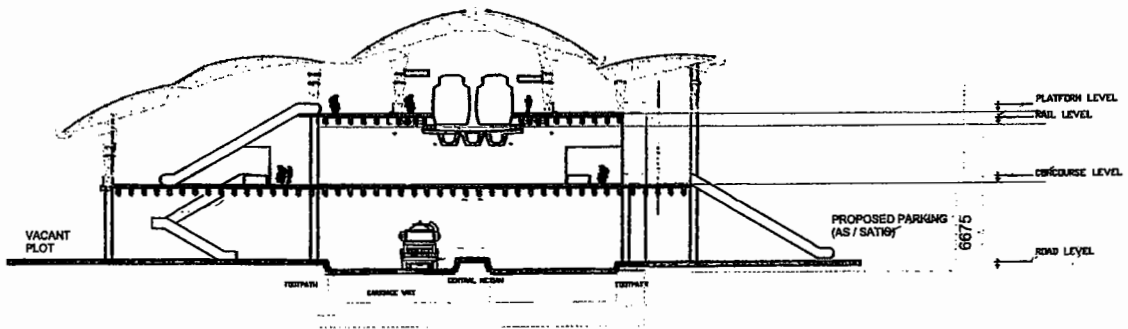

CROSS SECTION AT AA'

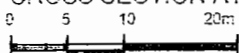

ANDHERI STATION
 Versova - Andheri - Ghatkopar
 East West MRTS Corridor
 Figure 4b



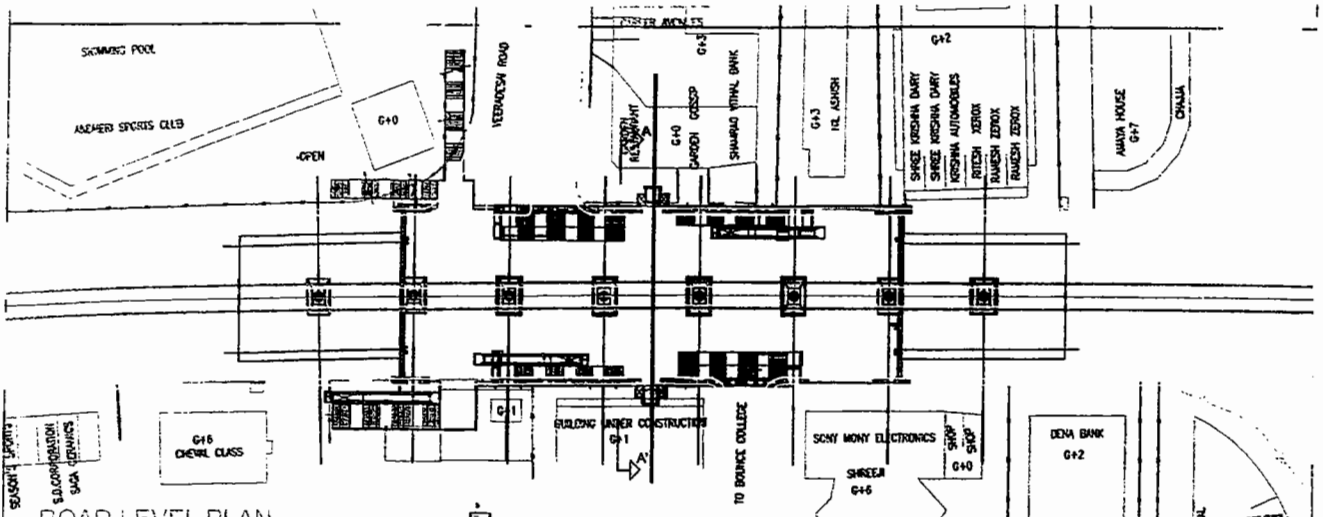

ROAD LEVEL PLAN

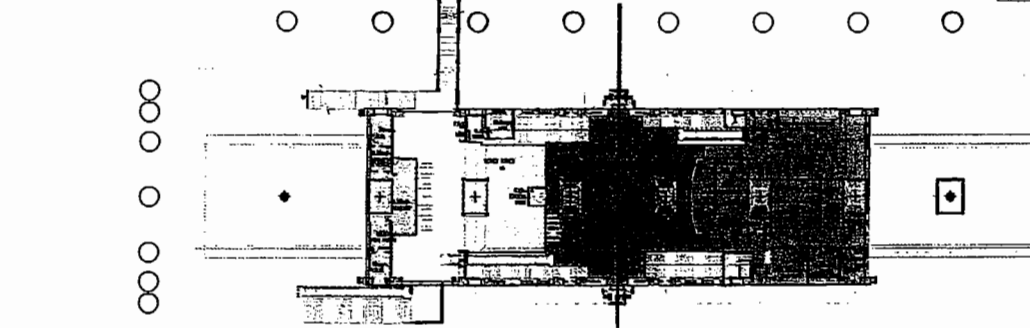

CONCOURSE LEVEL PLAN

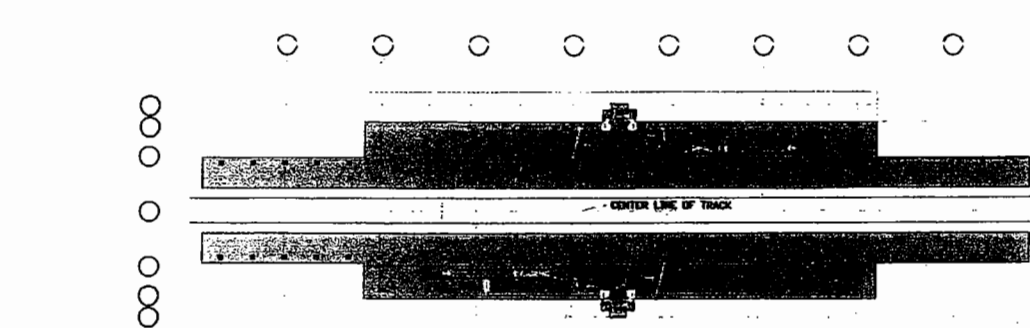

PLATFORM LEVEL PLAN

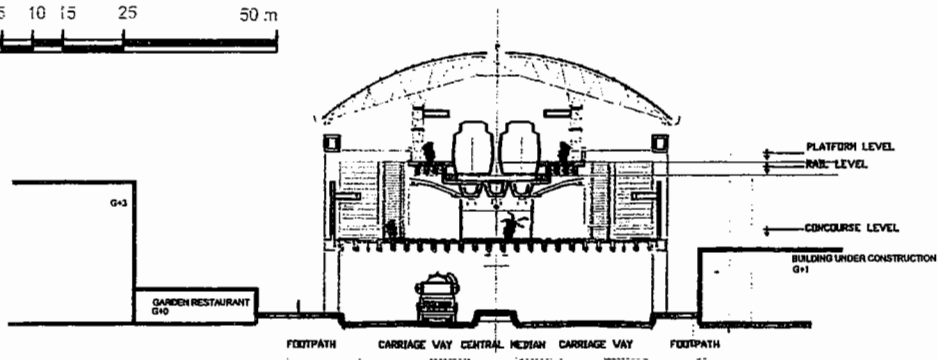

CROSS SECTION AT AA'



AZAD NAGAR STATION
Versova - Andheri - Ghatkopar
East West MRTS Corridor -
Figure 3



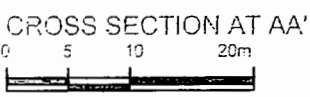
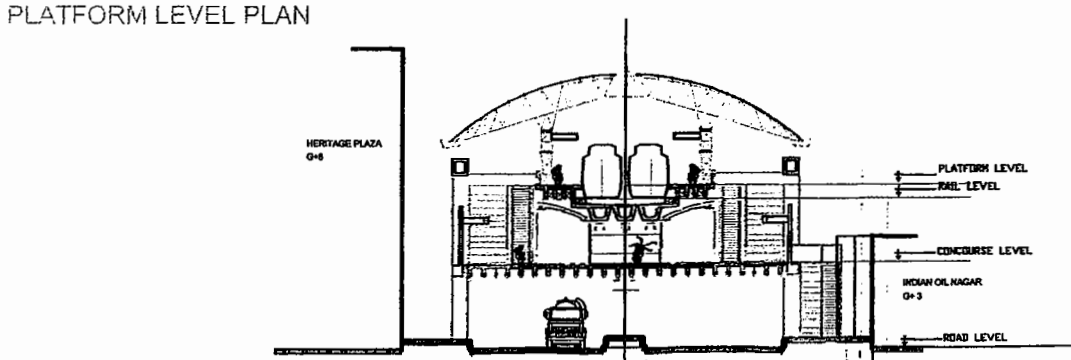
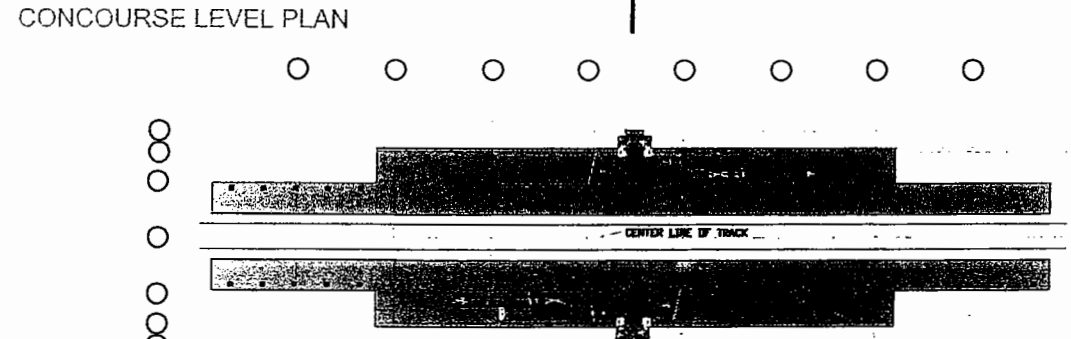
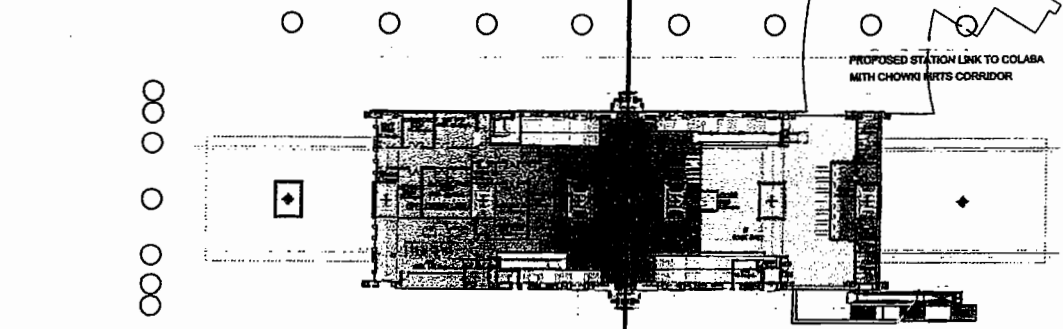
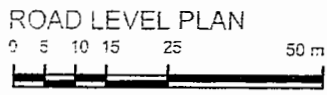
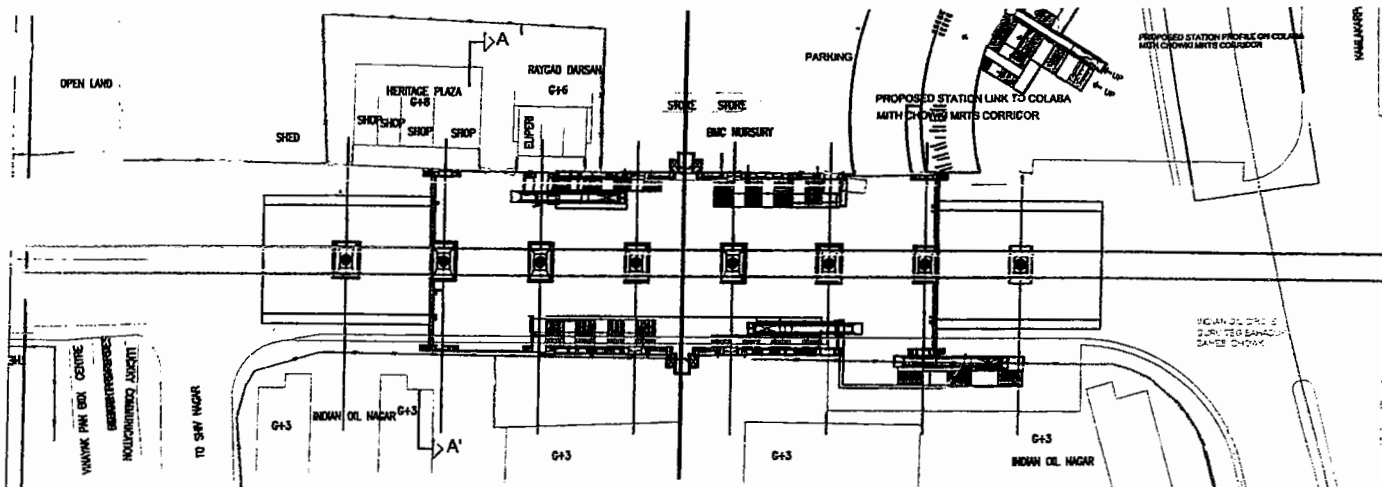

D N NAGAR STATION
Versova - Andheri - Ghatkopar
East West MRTS Corridor
Figure 2



PART C

**LAND DELETED FROM RESERVATIONS & RESERVED FOR "MRTS CAR
DEPOT / WORKSHOP AND ALLIED ACTIVITIES AND COMMERCIAL USE"**

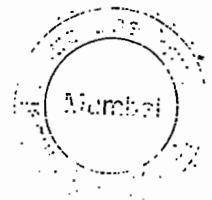

URBAN DEVELOPMENT DEPARTMENT
Mantralaya, Mumbai 400 032,
dated 12th July 2005.

MAHARASHTRA REGIONAL AND TOWN PLANNING ACT, 1966.

No.TPB. 4304/1430/CR-15/05/UD-11.—Whereas, the Development Plan of K(West) Ward of Greater Mumbai (hereinafter referred to as "the said Plan") has been sanctioned by the Government *vide* Urban Development Department's Notification No. 4392/5840/UD-11(RDP), dated 19th March 1993, under section 31 of the Maharashtra Regional and Town Planning Act, 1966 (hereinafter referred to as "the said Act") to come into force with effect from 4th May 1993 :

And whereas, the land bearing CTS No. 866, S. No. 111-A/B/C village Ambivali, Taluka Andheri admeasuring about 13.8 Ha. is reserved for— (i) Sewerage Plant (Site No. 580), (ii) Recreational Ground (Site No. 205), (iii) Housing for Dishoused (Site No. 549), (iv) Government Staff Quarters (Site No. 535), (v) Retail Market (Site No. 476) and (vi) 13.40 mt. wide Access Road (hereinafter referred to as "the said lands") ;

And whereas, the proposal for implementation of rail-based Mass Rapid Transit System (MRTS) along Versova-Andheri-Ghatkopar Corridor through Public Private Participation (PPP) has been approved by the Government for the purpose of which Government has appointed Mumbai Metropolitan Region Development Authority (MMRDA) as a 'Project Implementing Agency' ;

And whereas, the MMRDA *vide* letter No. T/ MMRDA/MRTS/2004, dated 12th January 2005 has requested Government to earmark the said land for MRTS Car Depot/Workshop and Allied Activities and Commercial use for Versova-Andheri-Ghatkopar Corridor which is identified as a part of Priority-I corridor of Mumbai Metro Master Plan ;

And whereas, after asserting the aforesaid facts, the Government finds it necessary to carry out certain changes in the reservation in the said lands by taking recourse to provisions contained in section of the said Act ;

And whereas, considering the urgency of the matter and the public purpose for which the said lands are required, Government is of opinion that the said lands should be reserved for "MRTS Car Depot/Workshop and Allied Activities and Commercial use" after following procedure laid down under section 37(IAA) of the said Act (hereinafter referred to as "the said modification") ;

And whereas, in view of the facts and circumstances mentioned above and in exercise of the powers contained in sub-section (IAA) of section 37 of the said Act, Government has issued the notice of even No. dated 16th February 2005 (hereinafter referred to as "the said notice") for inviting suggestions/objections from any person with respect to the said modification ;

And whereas, the said notice was published in the *Government Gazette* (Ordinary), dated 16th February 2005 and the said notice was published in the newspaper namely Vartahar, dated 23rd February 2005 and the *Midday*, dated 23rd February 2005 ;

भाग एक (को वि.पु.)—८

And whereas, as per the said notice Government has appointed Deputy Director of Town Planning; Greater Mumbai as an officer under section 162 of the said Act (hereinafter referred to as "the said officer") scrutinize any suggestions/objections received, grant hearing to the persons submitting suggestions/objections including Municipal Corporation of Greater Mumbai (hereinafter referred to as "the said Corporation") and to submit his report to the Government regarding the said modification ;

As reported by the said Officer Four suggestions/objection were received all of which were forwarded to the said Authority on 6th April 2005 as per the provisions under section 37(IAA) of the said Act ;

After completing the procedure as laid down under section 37(IAA) of the said Act, the said officer has submitted his report to Government on 29th April 2005 (hereinafter referred to as "the said Report") and whereas, hearing was granted by the said officer to the concerned persons including the MMRDA ;

And whereas, after consulting Director of Town Planning, Maharashtra State, Government is of opinion that said modification should be sanctioned with some changes.

Now, therefore, in exercise of the powers vested under section 37(2) of the said Act, Government hereby sanction the said modification as mentioned in the schedule below :—

Schedule

(A) "The land bearing CTS No. 866, S. No. 111-A/B/C village Ambivali, Taluka Andheri admeasuring about 13.8 Ha. reserved for—(i) Sewerage Plant (Site No. 580), (ii) Recreational Ground (Site No. 205), (iii) Housing for Dishoused (Site No. 549); (iv) Government Staff Quarters (Site No. 535), (v) Retail Market (Site No. 476) and (vi) 13.40 mt. wide Access Road are deleted from the reservation and reserved for "MRTS Car Depot/Workshop and Allied Activities and Commercial use" as shown on the plan attached herewith and the MMRDA shall be Appropriate Authority for this reservation.

(B) Buffer Zone of 30 mt. width shall be kept around the periphery of the said land so as to avoid noise pollution and only tree plantation shall be allowed in this buffer zone.

(C) Fixes the date of publication of this notification in the *Government Gazette* as the date of coming into force of this notification.

(D) Direct the MCGM that, in the schedule of modification sanctioning the said plan after the last entry, the schedule referred to as (a), (b) and (c) above shall be added.

By order and in the name of
the Governor of Maharashtra,

S. R. KINI,
Under Secretary to Government

Note.—This Notification is available on Government web site www.urban.maharashtra.gov.in

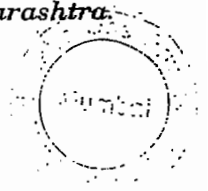

PART PLAN OF K/WESTWARD OF SANCTIONED
DEVELOPMENT PLAN OF GREATER MUMBAI.



SCALE : 1 : 4000

D. P. SHEET NO. W-38

LAND DELETED FROM RESERVATIONS &
RESERVED FOR "MRTS CAR DEPOT/
WORKSHOP AND ALLIED ACTIVITIES AND
COMMERCIAL USE"

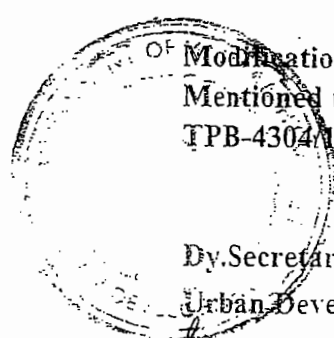
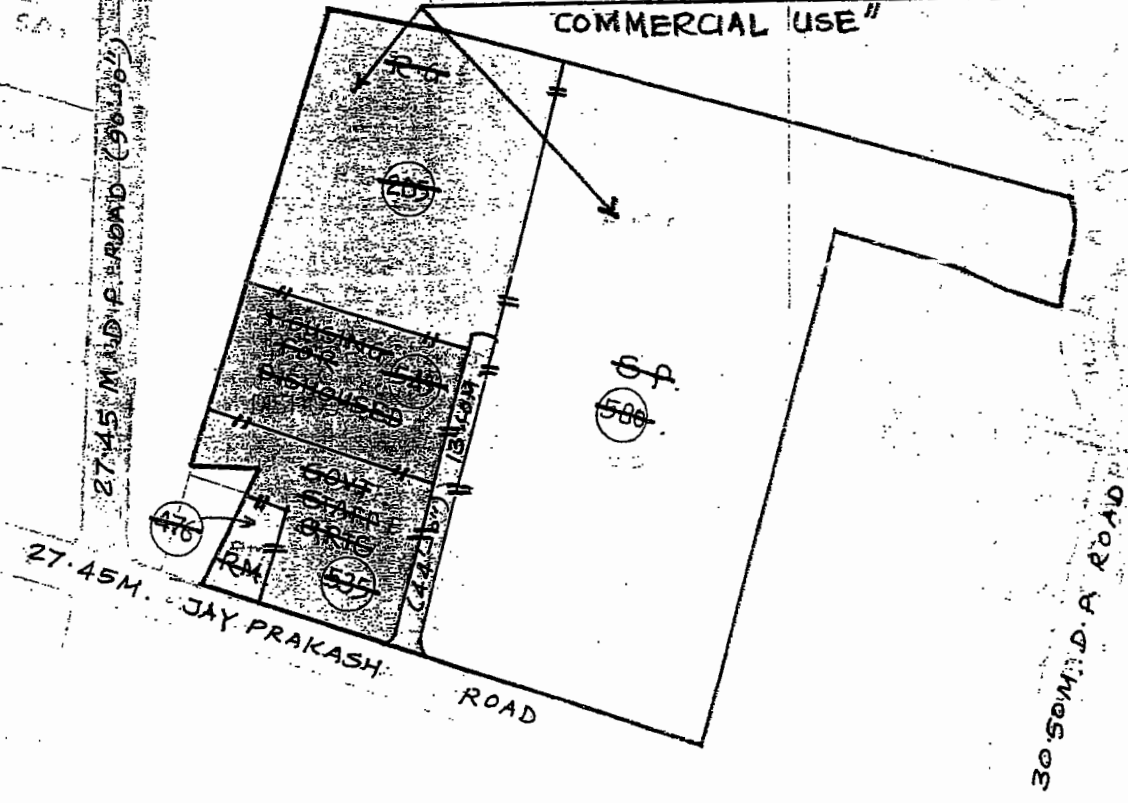

Modification sanctioned subject to the conditions
mentioned under Government Notification No.
TPB-4304/1430/CR-15/05/UD-11 dt.12/7/2005

Dy. Secretary to Government,
Urban Development Department.